



———— 2021 ————

SWIM SPAS

1300

1400

1600

1700

2100

Coast Spas Manufacturing
6315 202 Street, Langley BC Canada
604 514 8111
info@coastspas.com
www.coastspas.com



Thank you for choosing us!

Here at Coast Spas we have over 20 years of experience crafting the World's Best Built Spas®. Our mission is to deliver the highest quality spas with exceptional performance to help improve your overall wellness. We are so glad you've chosen a Coast Spa and we hope you, your family and friends all enjoy it for years to come.

Sincerely,

A handwritten signature in black ink, appearing to read "Patricia Diamente".

Patricia Diamente, CEO & President



CONGRATULATIONS!

YOU'RE ALMOST READY TO ENJOY YOUR NEW SPA!

Before you begin to enjoy your swim spa, please take a moment to submit your swim spa warranty. For registering your swim spa, you will need the swim spa serial number. Picture below will help you locate the serial number on your swim spa.

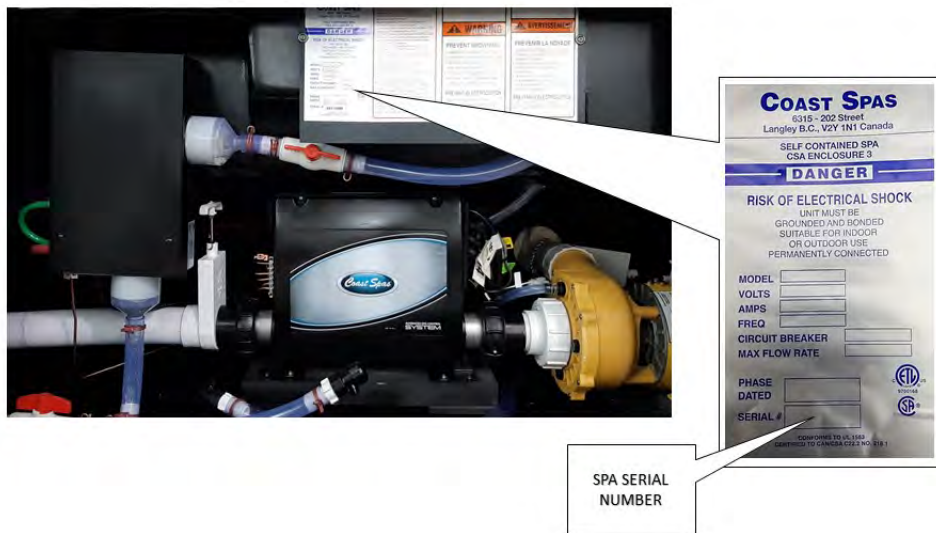

You can register your swim spa by using below link.
<https://coastspas.microsoftportals.com/>

FOR YOUR REFERENCE

Swim Spa owner name: _____

Address: _____

Contact: _____ Email: _____

Swim Spa Serial number: _____ Purchase Date: _____

Delivery Date: _____ Dealer Name: _____

Contact your swim spa selling dealer if you have any queries related to your swim spa. Coast spas authorized dealers are trained professionals who can assist you with swim spa parts, setup, operations, maintenance, and technical support.

DISCLAIMER: At the time of print, this manual is accurate in its information. Coast Spas reserves all the rights to change/modify any spa designs and/or features without notification. To check on updates or for other information, please visit www.coastspas.com

TABLE OF CONTENTS

Letter from Coast Spas Manufacturing Inc.	Page	2
Registering your swim spa	Page	3
Table of contents	Page	4
Basic information	Page	5
Important safety instructions and glossary of terms	Page	6-8
Preparation, set-up and location of your new swim spa	Page	8-13
Swim Spa general layout	Page	14
Swim spa collection	Page	15
Swim spa features	Page	16
Start Up Guide—Swim and exercise Spas, infinity edge swim spas	Page	17-18
Swim Spa Care Guide	Page	19-21
Basic Installation and Configuration Guidelines : Electrical Requirements	Page	21-22
Swim Spa Maintenance Procedures	Page	22-23
Water Quality, Diverter and Jet Maintenance	Page	23-24
Troubleshooting Guide	Page	25-27
Draining & Winterizing	Page	28
Swim Spa Controls	Page	29-44
Swim Spa Jet Operations	Page	45-50
Swim Spa Specifications	Page	51
Balboa Wi-Fi module	Page	52
ControlMySpa™	Page	53-56
PRV19 stereo system	Page	57
DM6 Instructions	Page	58
AQ-DM-6UBT– Digital media locker	Page	59
Del Ozone operation	Page	60
In.Clear Instructions	Page	60
Swim Spa Service Log	Page	61-62

IMPORTANT GFCI INFORMATION

Based on the testing conducted by the supplier of the true variable speed pumps, the Siemens brand GFCI can filter electrical spikes and avoid false trips. The use of a 60 Amp Siemens GFCI is recommended with the Atlas Swim System.



PLEASE READ YOUR ENTIRE OWNER'S MANUAL BEFORE SPA OPERATION



BASIC INFORMATION

WATER CARE

IMPORTANT: Caring for your water by ensuring proper chemical usage is the single most important thing you can do to keep your swim spa in good condition.

WARNING: Improper chemical usage and maintenance will quickly lead to severe issues with your spa and can effect the spa equipment, jets, pumps, and all other components in contact with the spa water.

All spas and swim spas are susceptible to damage from unbalanced spa water.

Always maintain your water chemistry within the following parameters.

pH	7.2 - 7.8
Chlorine	1.0 - 3.0 ppm
Bromine	2.0 - 5.0 ppm
Total Alkalinity	100 - 120 ppm
Calcium Hardness	150 - 250 ppm

ELECTRICAL

All self contained spas use 120VAC or 240VAC electrical spa packs.

120VAC: Requires an isolated 15 Amp circuit breaker, an isolated circuit with no other appliances or lights on the circuit at any time. Extension cords are not to be used in conjunction with the operations of the swim spa. Low voltage damage could result and this is not covered under warranty. **IMPORTANT: Spas with 110V means that the jets and heater will not work at the same time.**

NOTE: All components must be 120V. No 240V components allowable.

240VAC: Depending on the model of the spa, it will require either a 40, 50, or 60 Amp dedicated circuit breaker with the proper wire size (gauge) based on the length of the run.

The electrical circuit must be installed by a certified electrician and approved by a local building or electrical inspector.

SURFACE

Your new portable swim spa must be placed on a firm, flat and level surface, so that the weight is supported uniformly. We recommend no less than a 3" (93 mm) thick concrete slab. Wood decking or balconies must be constructed to support 150 pounds per square foot (730 kg/m²). Refer to the local and current building codes in your area. Should your new swim spa need to go through the gate or space –restricted area, ensure you've communicated those limitations with your dealer to avoid delivery complications.

NOTE: Damage caused by alternate decking methods may avoid the spa warranty. Contact your dealer if you have any questions regarding spa location and placement.

TRANSPORT

Your new swim spa has left the factory cleaned and polished and ready to begin operation after passing our many quality and operational tests. However, depending on your location in the world, your swim spa may have spend days or even weeks in transit before arriving at your home. Please ensure that before filling or operating your spa that you check all electrical and plumbing connections are securely connected in the equipment area as they might have loosened during shipping. If any dirt has accumulated, you will want to remove with a clean cloth or sponge using warm water.

IMPORTANT SAFETY INSTRUCTIONS

READ AND FOLLOW ALL INSTRUCTIONS CAREFULLY

DANGER: Risk of Injury. The suction fittings in this swim spa are sized to match the specific water flow created by the pump. Should the need arise to replace the suction fittings or the pump, be sure that the flow rates are compatible. Never operate the spa if the suction fittings are broken or missing. Never replace a suction fitting with one rated less than the flow rate marked on the original suction fitting.

DANGER: Risk of Accidental Drowning. Do not allow children to be in or around the swim spa without adult supervision. Keep the swim spa cover on and locked when not in use. See instructions enclosed with the cover for locking procedures.

DANGER: Risk of Electrical Shock. The electrical supply for this product must include a suitably rated switch or circuit breaker to open all ungrounded supply conductors to comply with section 422-20 of the National Electrical Code, ANSI/NFPA 70. The disconnect must be readily accessible and visible to the spa occupant but installed at least 5 feet (1.5 m) from the swim spa water.

READ, FOLLOW AND SAVE THESE INSTRUCTIONS

a) A green colored terminal or a terminal marked G, Gr, Ground, Grounding or the symbol * is located inside the supply terminal box or compartment. To reduce the risk of electric shock, this terminal must be connected to the grounding means provided in the electric supply service panel with a continuous copper wire equivalent in size to the circuit conductors that supply this equipment.

b) At least two lugs marked "Bonding Lugs" are provided on the external surface or on the inside of the supply terminal box compartment. To reduce the risk of electric shock, connect the local common bonding grid in the area of the spa to these terminals with an insulated or bare copper conductor not smaller than No. 6 AWG.

c) All field-installed metal components such as rails, ladders, drains or other similar hardware within 5 feet (1.5 m) of the spa shall be bonded to the equipment grounding buss with copper conductors not smaller than No. 6 AWG.

WARNING: To Reduce the Risk of Injury: The water in a spa should never exceed 104 °F (40 °C). Water temperatures between 100 °F (38 °C) and 104 °F (40 °C) are considered safe

for a healthy adult. Lower water temperatures are recommended for young children and when spa use exceeds 10 minutes. Since excessive water temperatures have a high potential for causing fetal damage during the early months of pregnancy, pregnant or possibly pregnant women should limit spa water temperatures to 100 °F (38 °C). If pregnant, please consult your physician before using a spa. Before entering the spa, the user should measure the water temperature with an accurate thermometer since the tolerance of water temperature regulating devices may vary as much as +/- 5 °F (2 °C). Persons suffering from obesity or a medical history of heart disease, low or high blood pressure, circulatory system problems or diabetes should consult a physician before using the spa.

CAUTION: Risk of Hyperthermia: Hyperthermia occurs when the internal temperature of the body reaches a level several degrees above the normal body temperature of 98.6 °F (37 °C). The symptoms of hyperthermia include drowsiness, lethargy, and an increase in the internal temperature of the body. Prolonged immersion in hot water may induce hyperthermia. A description of the causes, symptoms, and effects of hyperthermia are as follows:

- Unawareness of impending hazard;
- Failure to perceive heat;
- Failure to recognize the need to exit spa;
- Physical inability to exit spa;
- Fetal damage in pregnant women; and
- Unconsciousness and danger of drowning.

WARNING: Children should not use the spa without adult supervision.

WARNING: Do not use the spa unless all suction guards are installed to prevent body and hair entrapment.

WARNING: People with infectious diseases should not use a spa.

WARNING: To avoid injury, exercise care when entering or exiting the spa.

WARNING: Do not use drugs or alcohol before or during the use of a spa to avoid unconsciousness and possible drowning. The use of alcohol or drugs can greatly increase the risk of fatal hyperthermia in spas.

WARNING: Pregnant or possibly pregnant women should consult a physician before using a spa.

WARNING: Water temperature in excess of 38 °C (100 °F) may be injurious to your health. Before entering the spa, measure the water temperature with an accurate thermometer.

WARNING: Do not use the spa immediately following strenuous exercise.

WARNING: Prolonged immersion in a spa may be injurious to your health.

WARNING: Do not permit electric appliances (such as lights, telephone, radio, television, etc.) within 5 feet (1.5m) of the swim spa unless such appliances are built-in by the manufacturer.

WARNING: People using medication and/or having an adverse medical history should consult a physician before using a swim spa.

WARNING: People with infectious diseases should not use the swim spa.

WARNING: To avoid injury, exercise care when entering or exiting the swim spa.

WARNING: Do not use a swim spa immediately following strenuous exercise.

WARNING: Prolonged immersion in a swim spa may be injurious to your health.

WARNING: Maintain water chemistry in accordance with the manufacturer's instructions.

WARNING: The equipment and controls shall be located no less than 1.5 meters horizontally from the swim spa.

CAUTION: Observe a reasonable time limit when using the swim spa. Long exposures at higher temperatures can cause high body temperature. Symptoms may include dizziness, nausea, fainting, drowsiness, and reduced awareness. These effects could possibly result in drowning.

CAUTION: Enter and exit the swim spa slowly. Wet surfaces can be very slippery.

CAUTION: Proper chemical maintenance of swim spa water is necessary to maintain safe water and prevent possible damage to swim spa components. Maintain water chemistry in accordance with manufacturer's instructions.

CAUTION: Use the straps and clip tie downs to secure the cover when not in use. This will help to discourage unsupervised children from entering the swim spa and keep the swim spa

cover secure in high-wind conditions. There is no representation that the cover, clip tie-downs, or actual locks will prevent access to the swim spa.

CAUTION: For exercise, the water should not exceed 90 °F (32 °C).

GLOSSARY OF TERMS



AIR CONTROL: Mounted generally on the lip of the swim spa, it induces warm air from the equipment enclosure into the jet stream through venturi action.



WATER DIVERTER: The large diverter is used to divert water to various seats in the swim spa.



FILTER AIR RELIEF VALVE: Located on top of filter housing. Used to release air from the filter.



SKIMMER BLEEDER VALVE: Located inside the skimmer area or on the spa wall, needs to be loosened while filling the spa. This will help eliminate air from being trapped in the spa equipment.



OZONATOR: Available as an option. The ozonator produces natural ozone through the Corona Discharge process. Continuous use of an ozonator can dramatically reduce sanitizer consumption.



CONTROL BOX (PACK): Basically the "heart" of the spa. Power is distributed to any/all functions of the spa: pumps, ozonator, LED lighting, heater element, etc.



CONTROL PANEL: Mounted on the top lip of the spa and controls the functions of the spa.



EQUIPMENT ENCLOSURE: An enclosure that houses the control box, pump(s) and other electrical components.

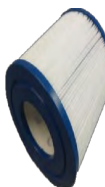

FILTER: The filter cleans the spa by passing water through a filter cartridge where debris and impurities are removed. Top load filter means the filter cartridge is accessible through the top of the spa. Front access skimmer means cartridge is accessed through door of skimmer.

DISCLAIMER: The pictures displayed above are for reference purpose only. Some parts may be different depending upon the spa model.



FLOOR DRAIN: The floor drain is covered by a grate-type cover and is utilized when draining the spa. It also acts as the return for the ozonator. You will see bubbles emitted from this drain, which is the result of water mixing with the ozone output.



GATE VALVES: Red with a grey handle is located at the inlet and outlet of the pumping system. Used while servicing the spa equipment, the valves open or close the water flow to the equipment. To remain open for normal use, turn fully counterclockwise.



KNIFE VALVES: A white "T"-handled valve, same functions as Gate valve (see above), except to open them you pull up on handle.



HEATER: The electronically controlled heater raises the temperature of the spa to the desired setting.



LEDs: LEDs and their special lenses can be used to achieve the desired mood lighting in the spa and spa jets.

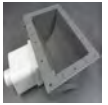

SKIMMER: This is the rectangular outlet at the water level. The skimmer removes surface debris to the filter. The water level in the spa should be kept $\frac{1}{2}$ to $\frac{3}{4}$ up on the skimmer for optimum operation.

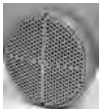

SUCTION: During operation of the equipment, the suction works in conjunction with the skimmer to draw water from the bottom of the spa through the filter, keeping the spa sparkling clean.



NECK JET: Direction-controllable jet for soothing neck massage.



ADJUSTABLE CLUSTER JET: Our adjustable, high-intensity hydrotherapy jet.



DIRECTIONAL JET: Provides a straight flow for a therapeutic massage



ROTATIONAL JET: Provides a Unidirectional circular therapeutic massage.



MASSAGE JET: Delivers massage in staccato bursts over a narrow, focused area.



VOLCANO/WHIRLPOOL JET: high-output jet designed for foot and leg massage.



LAMINAR FLOW: A thin stream of water that arcs from the spa lip.

PREPARATION, SET-UP AND LOCATION FOR YOUR NEW SPA:

- You want to keep in mind how you intend to use the spa and plan the location accordingly.
- How close is the spa from the exit or entrance to your house? (consider the cold weather)
- Is the path to your spa clean of debris, sand, grass? (so as not to track into the spa).
- Is there protection from wind, inclement weather?
- Can neighbors or passersby see the spa?

NOTE: *Allow for service access:* Many swim spa owners enjoy placing their spa in a decorative enclosure or a deck. Keep in mind that you need to have access to the equipment for maintenance and the swim spa should be able to be moved or lifted without destroying the special enclosure or its surroundings. You should discuss this with your dealer when designing the location. Extension cords are not to be used in conjunction with the operations of the spa. Low voltage damage could result and this is not covered by warranty.

DISCLAIMER: The pictures displayed above are for reference purpose only. Some parts may be different depending upon the spa model.



1302 BENCH & LOUNGE - SAFE HANDLING / UNLOADING INSTRUCTIONS

CAUTION!



- Use 6" wide straps that are at least 30 feet in length to support the base of the swim spa during lifting.
- Ensure the straps are in good working condition prior to unloading the swim spa (ie. No rips, wear or tear).
- Ensure the straps are evenly spaced at 30" from each end (see diagram below). Spacing the straps may require slight adjustments to ensure the load is balanced.
- The chains attached to the crane must be a minimum of 18 feet in length from the point of lifting. Using chains smaller than 18 feet will add stress to the outer lip of the swim spa and may result in damage.
- Using the appropriately weighted straps and chains is important to ensure the safe handling of the 1300 LOUNGE & PARTY Swim Spa. Please consult your crane operator for more information.

Note: Damage during transportation or from mishandling or improper lifting is not covered by the CSMI Warranty.

Note: Never lift or handle the spa by the swim plumbing or equipment.

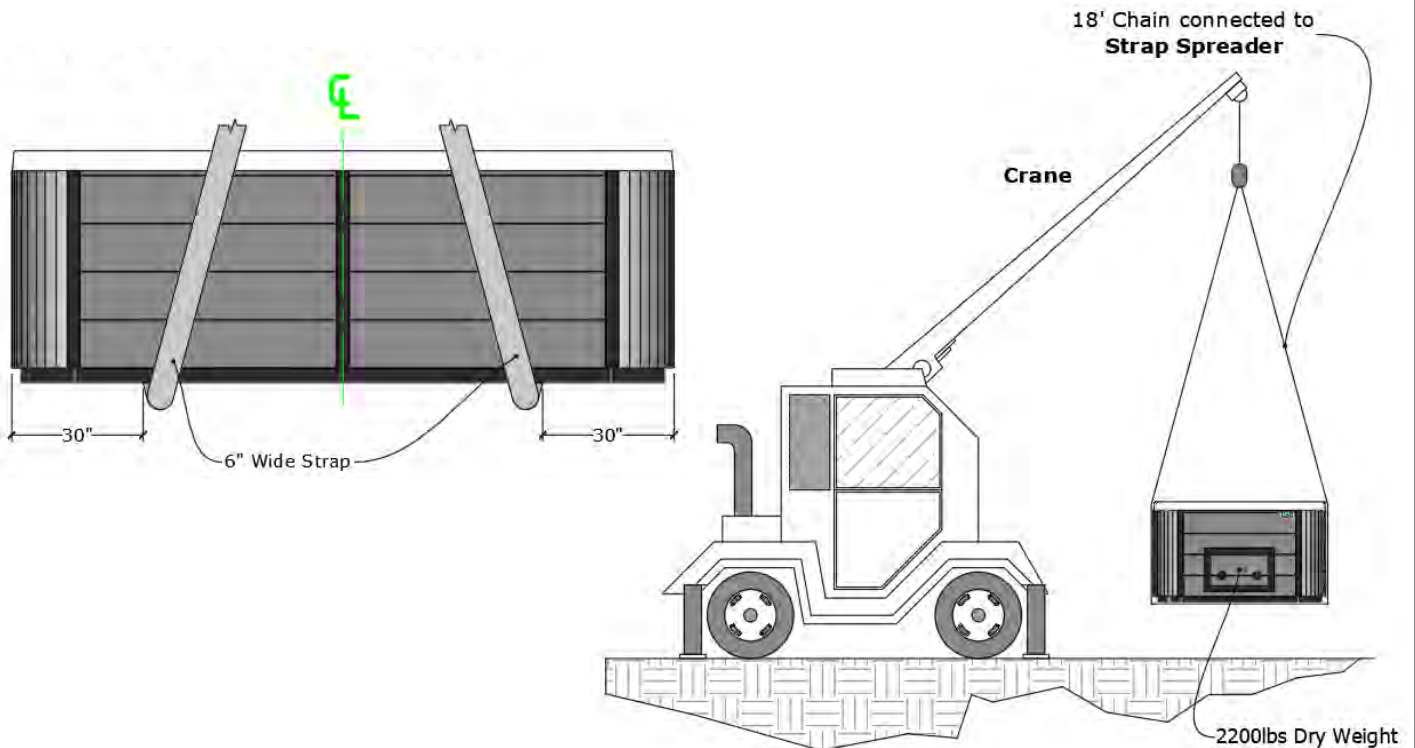



1400 VANISHING EDGE - SAFE HANDLING / UNLOADING INSTRUCTIONS

CAUTION!



- Use 6" wide straps that are at least 30 feet in length to support the base of the swim spa during lifting.
- Ensure the straps are in good working condition prior to unloading the swim spa (ie. No rips, wear or tear).
- Ensure the straps are evenly spaced at 33" from each end (see diagram below). Spacing the straps may require slight adjustments to ensure the load is balanced.
- The chains attached to the crane must be a minimum of 18 feet in length from the point of lifting. Using chains smaller than 18 feet will add stress to the outer lip of the swim spa and may result in damage.
- Using the appropriately weighted straps and chains is important to ensure the safe handling of the 1400 VE Swim Spa. Please consult your crane operator for more information.

Note: Damage during transportation or from mishandling or improper lifting is not covered by the CSMI Warranty.

Note: Never lift or handle the swim spa by the plumbing or equipment.

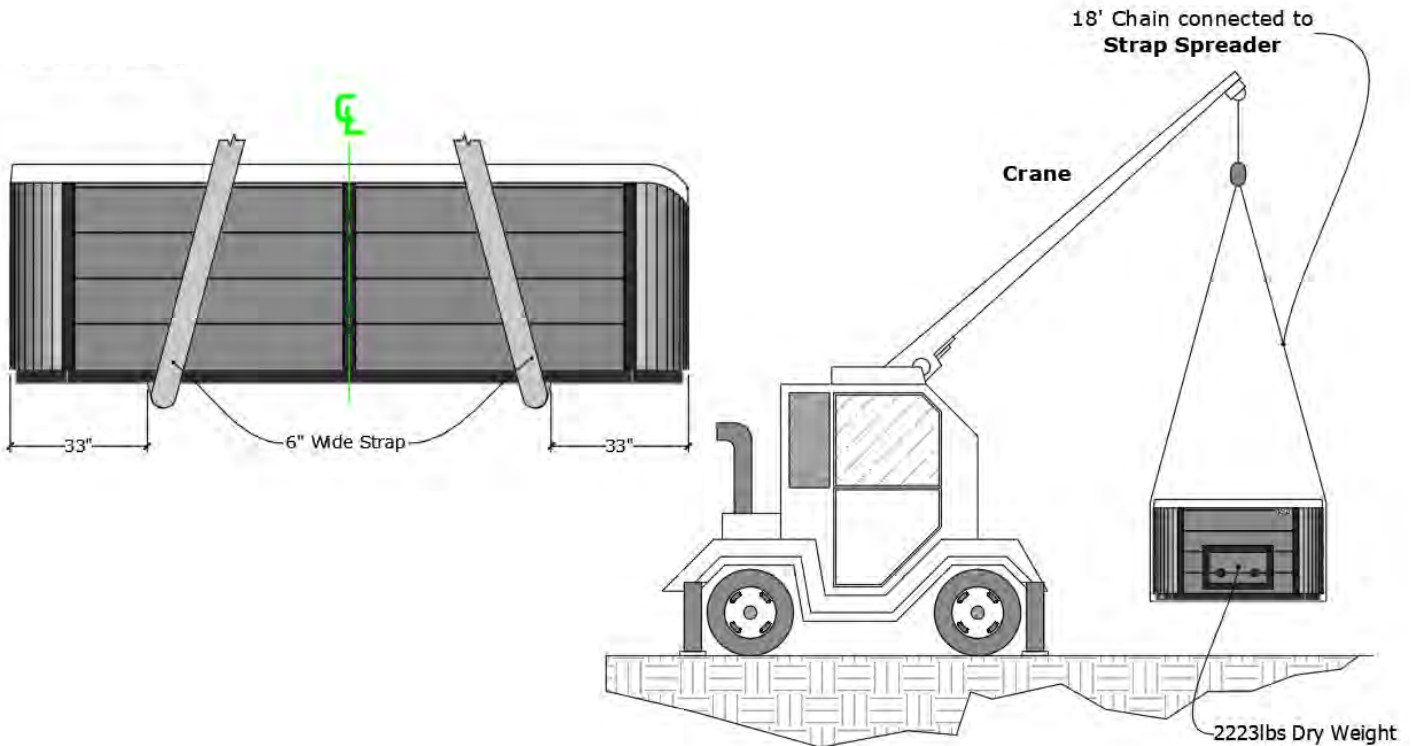



1600 - SAFE HANDLING / UNLOADING INSTRUCTIONS

CAUTION!



- Use 6" wide straps that are at least 30 feet in length to support the base of the swim spa during lifting.
- Ensure the straps are in good working condition prior to unloading the swim spa (ie. No rips, wear or tear).
- Ensure the straps are evenly spaced at 40" from each end (see diagram below). Spacing the straps may require slight adjustments to ensure the load is balanced.
- The chains attached to the crane must be a minimum of 18 feet in length from the point of lifting. Using chains smaller than 18 feet will add stress to the outer lip of the spa and may result in damage.
- Using the appropriately weighted straps and chains is important to ensure the safe handling of the 1600 Swim Spa. Please consult your crane operator for more information.

Note: Damage during transportation or from mishandling or improper lifting is not covered by the CSMI Warranty.

Note: Never lift or handle the swim spa by the plumbing or equipment.

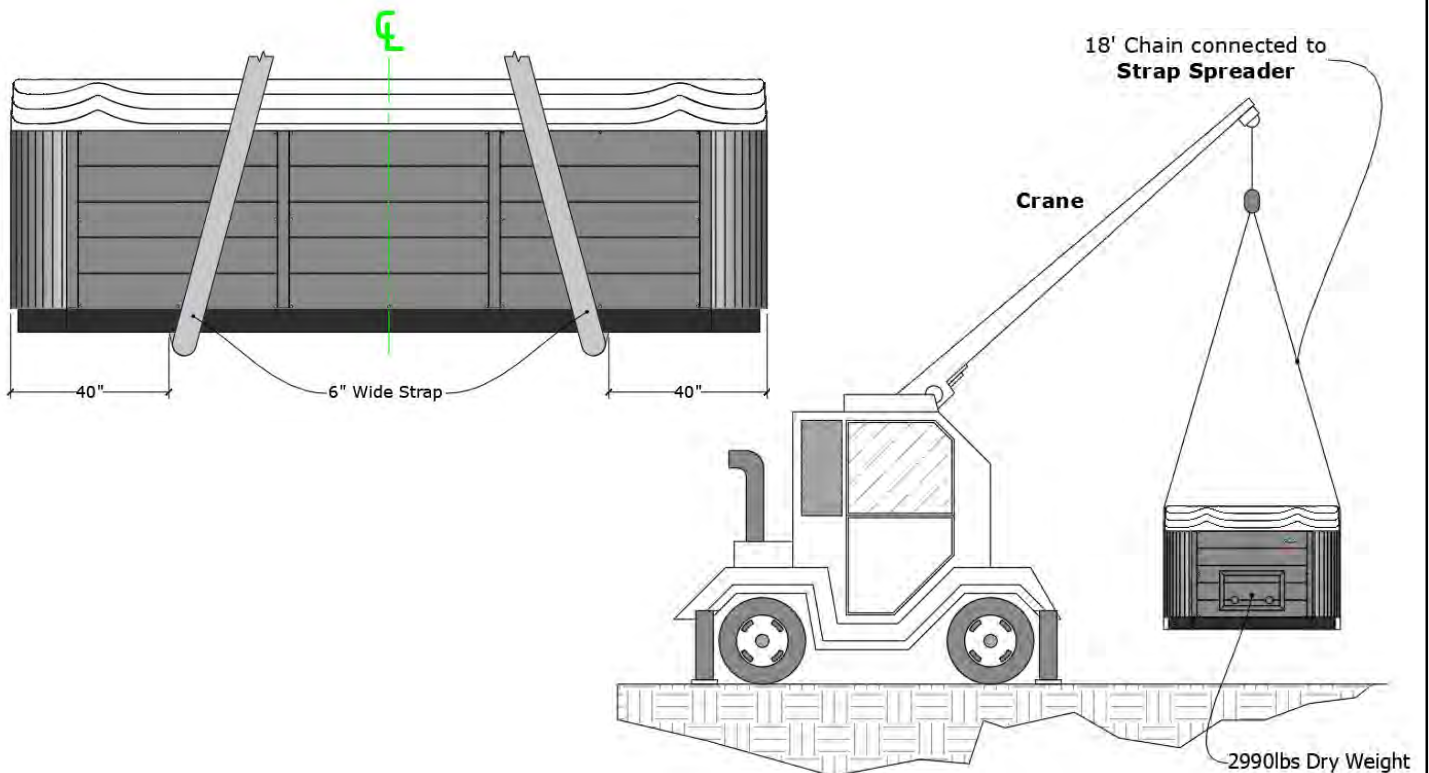



1700 INFINITY ULTRA - SAFE HANDLING / UNLOADING INSTRUCTIONS

CAUTION



- Use 6" wide straps that are at least 30 feet in length to support the base of the swim spa during lifting.
- Ensure the straps are in good working condition prior to unloading the swim spa (ie. No rips, wear or tear).
- Ensure the straps are evenly spaced at 44" from each end (see diagram below). Spacing the straps may require slight adjustments to ensure the load is balanced.
- The chains attached to the crane must be a minimum of 18 feet in length from the point of lifting. Using chains smaller than 18 feet will add stress to the outer lip of the swim spa and may result in damage.
- Using the appropriately weighted straps and chains is important to ensure the safe handling of the 1700 IU Swim Spa. Please consult your crane operator for more information.

Note: Damage during transportation or from mishandling or improper lifting is not covered by the CSMI Warranty.

Note: Never lift or handle the swim spa by the plumbing or equipment.

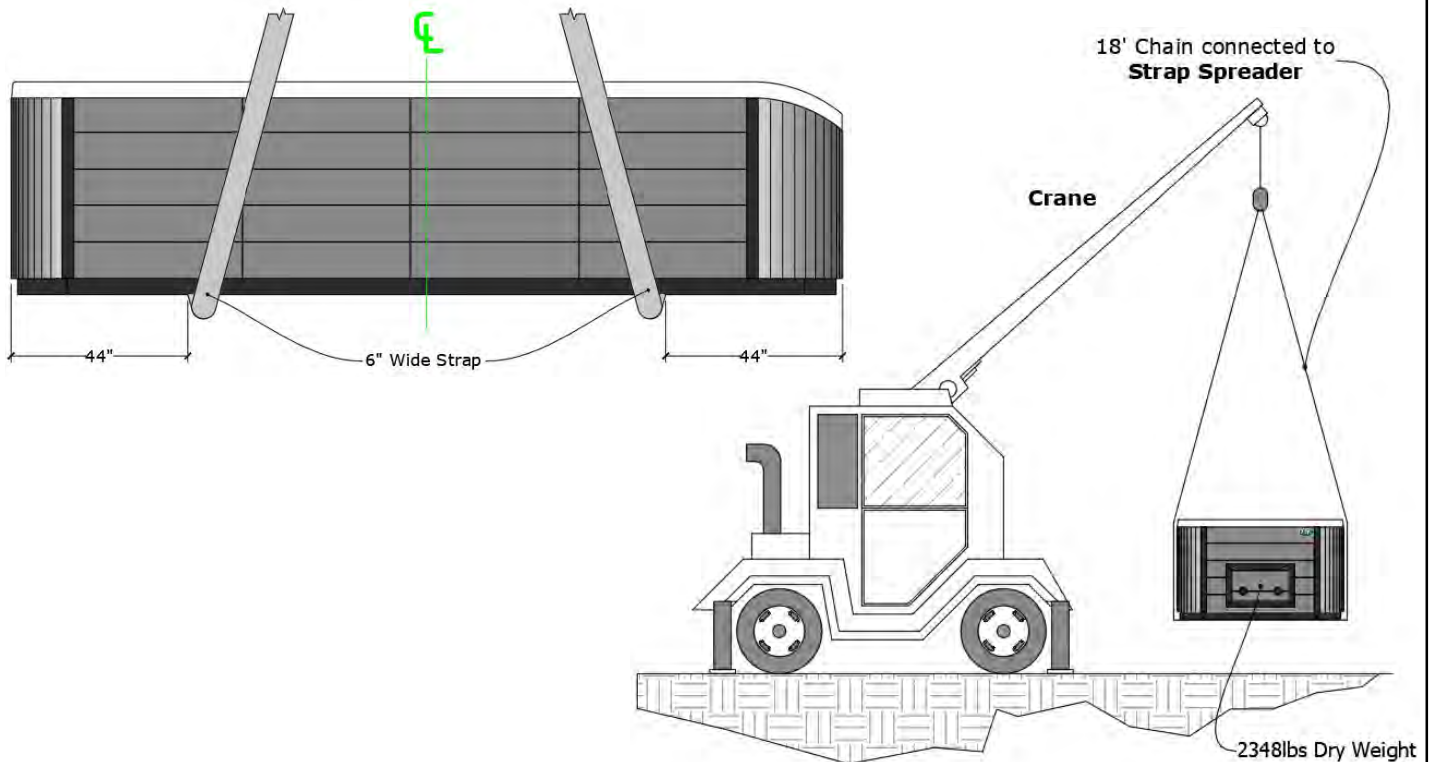



2100 - SAFE HANDLING / UNLOADING INSTRUCTIONS

CAUTION!



- Use 6" wide straps that are at least 30 feet in length to support the base of the swim spa during lifting.
- Ensure the straps are in good working condition prior to unloading the swim spa (ie. No rips, wear or tear).
- Ensure the straps are evenly spaced at 66" from each end (see diagram below). Spacing the straps may require slight adjustments to ensure the load is balanced.
- The chains attached to the crane must be a minimum of 18 feet in length from the point of lifting. Using chains smaller than 18 feet will add stress to the outer lip of the spa and may result in damage.
- Using the appropriately weighted straps and chains is important to ensure the safe handling of the 2100 VE Swim Spa. Please consult your crane operator for more information.

Note: Damage during transportation or from mishandling or improper lifting is not covered by the CSMI Warranty.

Note: Never lift or handle the swim spa by the plumbing or equipment.

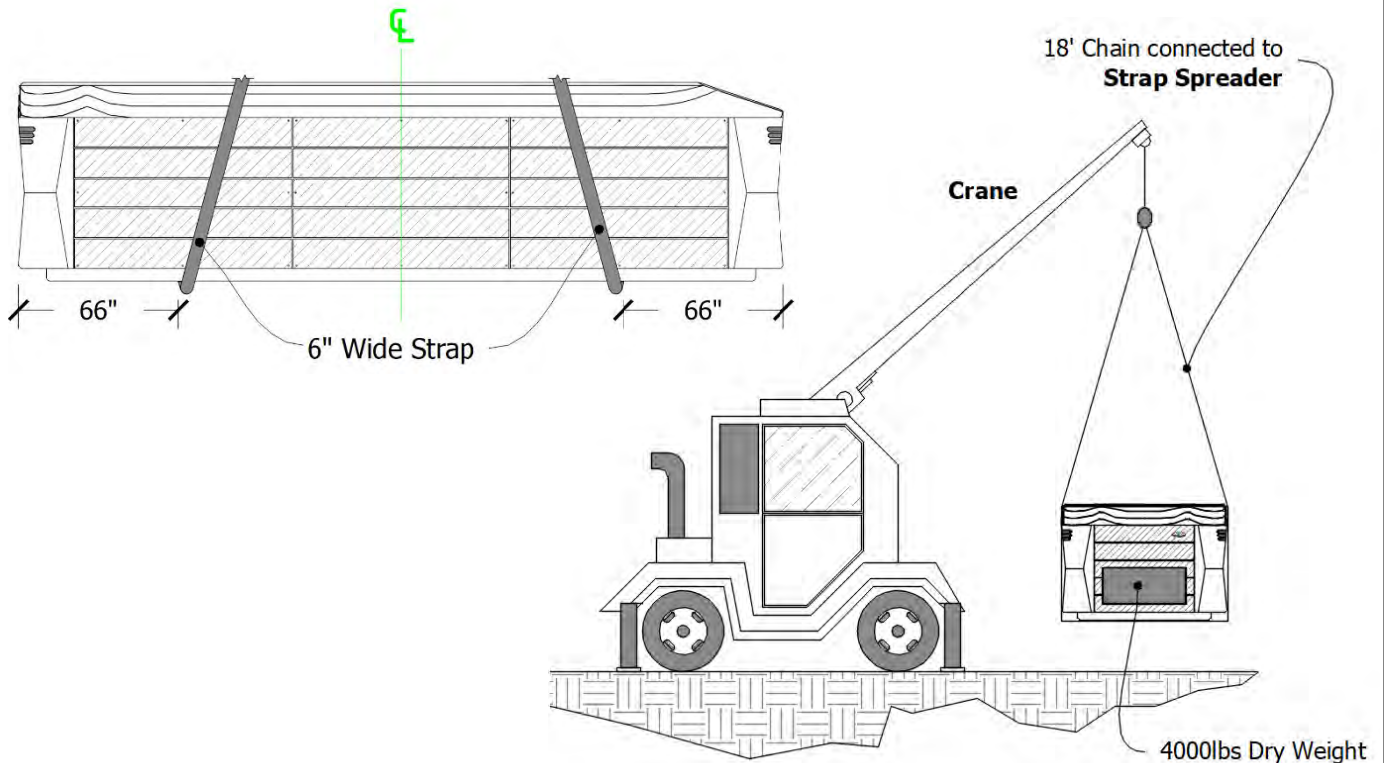

SWIM SPA GENERAL LAYOUT

(Your swim spa may look different)



- | | |
|---|---------------------------------|
| 1. Pillows | 12. Ozone bleeds the shut valve |
| 2. Air Control | 13. Drain for Cubby/Ozone |
| 3. Extreme XL Water Diverters | 14. Suction |
| 4. Hydro Cyclonic Water Filtration System | 15. Levitator Jets |
| 5. Swim Tether | 16. Spa Drain |
| 6. Swim Spa Control Panel | 17. River Jet Atlas System |
| 7. Massage Jets | 18. Skimmer |
| 8. Laminar Shut Off | 19. Handles |
| 9. Poly Jets | 20. Spa LED |
| 10. Cluster Jets | 21. Laminar Flow Jets |
| 11. 7' LED Light | |

DISCLAIMER: The pictures displayed above are for reference purpose only. Some parts may be different depending upon the swim spa model.

DISCLAIMER: At the time of print, this manual is accurate in its information. Coast Spas reserves all the rights to change/modify any swim spa designs and/or features without notification. To check on updates or for other information, please visit www.coastspas.com.

SWIM SPA COLLECTION



1302 Bench Performance Series



1302 Lounge Performance Series



1400 VE Wellness Spa® Series



1600 Wellness Spa® Series



1700 VE Wellness Spa® Series



2100 VE Wellness Spa® Series

DISCLAIMER: The pictures displayed above are for reference purpose only. Some parts may be different depending upon the swim spa model.

DISCLAIMER: At the time of print, this manual is accurate in its information. Coast Spas reserves all the rights to change/modify any swim spa designs and/or features without notification. To check on updates or for other information, please visit www.coastspas.com.

THE SWIM COLLECTION INCLUDES

Choose model to see specific features and options. All features below may not be included with all models.



Extreme XL Water Diverters LED. Divert the flow of water to specific seats in your Spa.



Air Controls. Allow air to mix with the water being supplied to your massage jets.



Our Luxury Trillium Jets. Luxury Trillium Jets are made to deliver the ultimate hydrotherapy experience.



Air Blower (North America) with 18 Stainless Steel Air Injector Jets.



Our Swim Spa River Jets are each powered solely by a 4HP (6BHP) HyperFlow Jet Pump. The swimmer can adjust the direction of the water flow for each River Jet to ensure their swimming experience is perfect for their swimming style.



Streaming water ropes provides the soothing sound of running water. Adds a stunning look to the profile of the Spa.



Coast Spas developed the Hydro Cyclonic Filtration System®. Not only is it more efficient and faster than a skim filtration system but it also removes the dirty filter canisters from the bathing area.



Swim Tether Anchor Plate. Allows you to add the swim tether at any time.

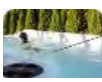

Swim Tether. Allows you to swim in place with or without the river functioning. Helps to keep the swimmer in the center of the swim lane.



Your Spa has the ability to be equipped with the Worldwide Spa Remote hardware that is required to take advantage of nearly limitless control and monitoring of your Spa.



O3 One Advanced Plasma Discharge Ozone produces a higher concentration of energetic oxygen or "ozone" that oxidizes foreign contaminants.



The Coast Cubby allows for dry storage your items in a protected marine-grade compartment.



7" Stainless Steel Frosted Light Dome. Long lasting, bright and energy efficient.



DM6 Dock & Bluetooth Stereo-2 Flush mount Speakers with Subwoofer: Protective dock and enclosure for your smartphone or mp3 player.



Aromatherapy - Fragrance Injection System with a push of a button add a burst of fragrance into your Swim Spa.

SPA COMFORTS

- Programmable Filtration
- Stainless Steel Oversized Monster™ Skimmer

BUILT TO LAST

- Freeze Protection
- Formed Equipment Enclosure
- Owens Corning® Fiberglass Shell with 1.25" Steel Reinforcement
- Steel Reinforced Spa Acrylic
- Pressure Treated Frame
- Quick Access Gate Valves
- Titanium Heater
- Recessed Floor Drain
- Recessed Thread-In Jet-Pockets™
- Super-Sealed™ Barb & Clamp Plumbing
- Full Swim and Exercise Area
- Anti-Slip Textured Floor
- Plush Headrests
- Beverage Holders



START UP GUIDE

SWIM & EXERCISE SPAS

PREP FOR FILLING

! PLEASE READ ALL INSTRUCTIONS BELOW BEFORE FILLING THE SPA



Using a cloth and water, wipe away any dirt/dust collected from transport. Ensure all jets are open by turning the face counter clockwise.



Ensure all plumbing and electrical connections are securely connected and tightened as they can come loose during transit.



Ensure that any gate/knife valves are fully open.



Remove the filter lock ring and lid.



Remove filter and take it out of the plastic transport bag. Leave filter canister open when filling.



Remove skimmer cavity grate cover by sliding it upwards.



Loosen (do not remove) the air bleeder valve located in the skimmer cavity.

FILLING YOUR SPA

! DO NOT USE HOT WATER TO FILL YOUR SPA

! DO NOT USE WATER FROM A WATER SOFTENER



Place fill hose into open filter canister and fill hot tub until water is 2/3 of the way up the skimmer opening.



When filled all massage jets (excluding neck jets) should be under water.



Remove fill hose from filter canister.



Put filter back into filter canister. Then put back on the filter canister lid and tighten locking ring.

POWERING UP YOUR SPA



Turn power on at the main breaker.

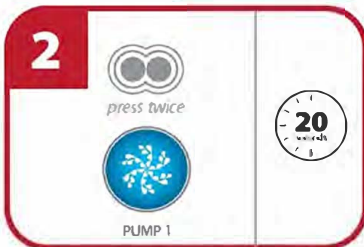

Turn pump 1 on high speed for 20 seconds by pressing the pump icon twice.

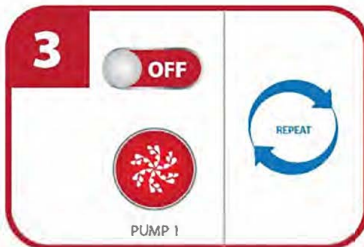

Turn pump 1 off by pressing the pump one icon once. Repeat steps 2 and 3 until air is removed from pump 1 and water is coming from jets.



Tighten the air bleeder valve located in the skimmer cavity. Set your hot tub temperature. Get ready to enjoy!



START UP GUIDE

INFINITY EDGE SWIM SPAS

PREP FOR FILLING

! PLEASE READ ALL INSTRUCTIONS BELOW BEFORE FILLING THE SPA



Using a cloth and water, wipe away any dirt/dust collected from transport. Ensure all jets are open by turning the face counter clockwise.



If your spa has a Crystal Clear tube the threaded plug needs to be on prior to filling the spa.



Remove the filter lock ring and lid. Remove filter and take it out of the plastic transport bag.



Put the filter back inside and secure the lid firmly with the locking rig. Loosen air-bleed screw.

FILLING YOUR SPA

! DO NOT USE HOT WATER TO FILL YOUR SPA

! DO NOT USE WATER FROM A WATER SOFTENER

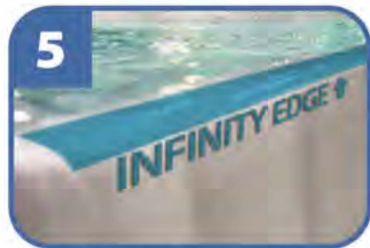

Place fill hose inside the spa and fill main body of spa with water until it reaches the infinity edge. Allow water to spill over infinity edge for approximately 60 seconds.

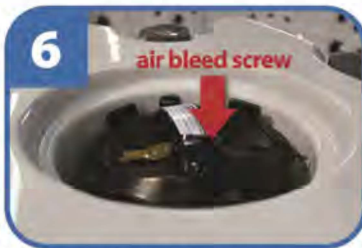

Tighten air-bleed screw.



Turn power to the spa on from GFCI breaker to activate water level gauge. Continue filling until the water gauge reads just above 1/2 full.



Turn power to the spa off from the GFCI breaker for 30 seconds and then turn back on.

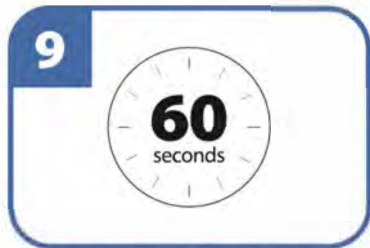

Do not press the back and/or pump #1 button on the control panel. Activate high speed on pumps 2 & 3 (if 3-pump model) or pump 2 (if 2-pump model) by pressing the pump buttons twice. Let run for 60 seconds.

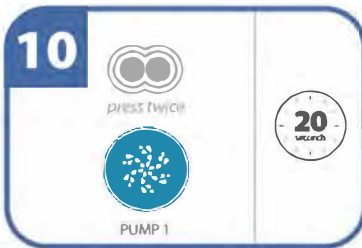

Continue running pumps 2 & 3 (pump 2 on 2-pump models), turn pump 1 on high speed for 20 seconds by pressing the pump 1 icon twice.

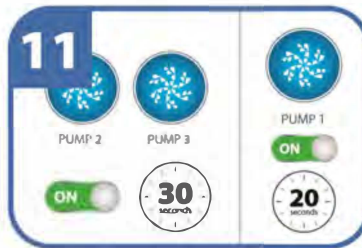

Continue running pumps 2 & 3 (pump 2 on 2-pump models) on high speed for 30 seconds and activate pump 1 on high speed for 20 seconds.



Cascade check valve inside the equipment area, full of water is an indication of no more air in the plumbing line. If the check valve is not full of water, air is still in the plumbing lines.



Release any additional trapped air by loosening the air bleed screw. Wait for all air to be released. Retighten.

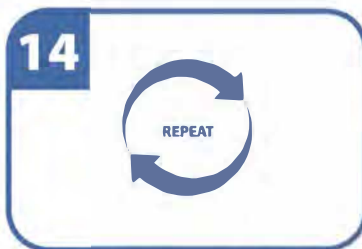

Repeat steps 11-12 until all air has been removed from the system. If air is still in the system it will precede water coming out of the jets when pump 1 is activated.



Turn off all pumps. Then turn main power off to the spa for 30 seconds. Then turn power back on.

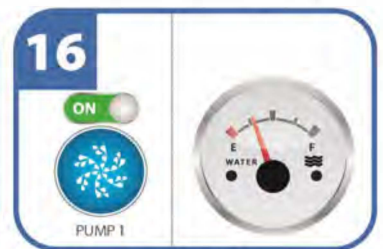

Your water level should read just above 1/4 on the gauge when pump 1 (high speed) is activated. **Your hot tub is now filled. Set the temperature and get ready to enjoy!**

IMPORTANT: Your Infinity Edge Spa will have an additional drain valve that will drain water from the reserve tank. This is separate from the main spa drain system.

SPA CARE GUIDE

Your Authorized Dealer carries a wide variety of care and maintenance products. For more information please contact your Dealer.

REQUIRED FILTER MAINTENANCE

Your new swim spa is equipped with a filter cartridge. To ensure maximum water quality at all times, you should replace the filter cartridge every six months, or earlier as necessary. The filter cartridge is designed to be thrown away! Attempts to re-use the filter cartridge may result in the re-release of unwanted particles back into the spa.

PLEATCO DUAL CORE FILTERS

Your spa comes with a premium filter. Most come with equipped with a Pleatco DualCore Filter, which does a better job of cleaning your spa water than any other filter cartridge. The DualCore filter has two layers of filtration media, the outer layer and the inner layer. Both are engineered to remove different particles from your water.



The outer core is similar to a traditional filter which traps larger debris, while the inner core filters the water for particles down to 3 microns in size. The inner core is easily removed and both filter media can be cleaned.

Keeping your spa water clean and refreshing is extremely important for your enjoyment of your swim spa. Our spas come with only the best filters available in order to ensure your satisfaction.

REQUIRED WATER REPLACEMENT

You should replace the spas water every 3-6 months. The frequency will depend on a number of variables including frequency of use, number of bathers and attention paid to the water quality maintenance. You will know it is time for a change when you can no longer get the normal feel or sparkle to the water,

even though the key water balance measurements are all within the recommended ranges.

HEADREST / PILLOW CARE

The pillows can be removed for easy cleaning and maintenance. All pillows have plugs within the pillow itself. To remove the pillow, grab the bottom edge firmly and pull outward. This will allow the pillows to pop-out from the receptacle in the spa shell. To reinstall the pillow you will align the pillow plug with the receptacle. Press/hit the front side of the pillow firmly, which will insert the plug back into the receptacle.

- **Proper water chemistry must be maintained. Your swim spa pillows are easily and quickly damaged when exposed to unbalanced spa water.** If you suspect that your chemicals may be unbalanced, remove your pillows immediately until the water has been restored to suggested conditions.
- Do not sit on the pillows
- Do not pull on the pillows
- Pillows should be cleaned using a soft cloth and mild soap, then wiped with a conditioner. We recommend that pillows be washed each time you drain your spa.

This Limited Warranty is void if failure is caused by accident, acts of nature, acts of God, or other causes beyond the control of CSMI. Neglect, misuse and abuse include any installation, operation, or maintenance of the spa other than in accordance with the instructions contained in the owner's manual provided with the spa, including, but not limited to damage caused by operation outside the range of 34 degrees Fahrenheit and 116 degrees Fahrenheit or 1 degree Celsius and 47 degrees Celsius .

Please be advised that the Spa Warranty will become void if Coast Spas or any of its selling or servicing agents determines that the spa has been exposed to Hydrogen Peroxide, TriChlor or any substance using it as an ingredient proven to be dangerous to the Spa. Any condition arising from the use of Hydrogen Peroxide or TriChlor on the Spa is not a warrantable defect.

SWIM SPA INTERIOR

Your swim spa has a fiberglass reinforced acrylic shell. Generally dirt and stains will not adhere to the surface. To properly clean the surface, we recommend wiping it with a soft

damp cloth (or sponge) using a low sudsing household soap or liquid detergent and rinsing thoroughly with fresh water. Stubborn dirt or stains may be removed by using Spic & Span adequately dissolved in water. Contact your dealer and inquire about maintenance packages.

DO NOT use any cleaning products containing abrasives or solvents, since these could damage the surface. Harsh chemicals should never be used on acrylic surfaces. Damage to the shell due to the use of harsh chemicals is not covered under the warranty.

DO NOT leave your swim spa drained and in direct sunlight for extended periods of time. Extreme heat could cause damage to the acrylic surface and may induce an effect known as "crazing". Crazing is not covered under spa limited warranty.

STAINLESS STEEL CONTROLS AND COMPONENTS ABOVE THE WATER LINE

To preserve the stainless steel finish of the controls and components above the water line, we recommend they be wiped with a dry soft cloth after each use of your swim spa. In addition, off-gas your tub by removing the cover for approximately 30 minutes multiple times per week (if not in use) and after every shock treatment.

CABINET CARE

Never spray cabinets with a high-pressure garden hose or pressure washer for any reason. This action may induce an electrical short in the swim spa's electrical equipment.

CEDAR CABINET

Our cedar cabinets are made from top quality Western Cedar and manufactured and stained at our factory. With proper care and maintenance, your cedar cabinet should maintain its beauty for many years. Manufacturer recommends touch-up or re-staining of the cabinet every three to four years depending on your environment. Contact your Dealer for re-staining procedures.

VINYL CABINET

Vinyl cabinets are made of a rigid polymer that combines the durability of plastic with the beauty of real wood. This cabinet is manufactured so that it won't crack, peel, blister or delaminate even after prolonged exposure to the elements. We recommend wiping the cabinet with a soft damp cloth (or sponge) using household soap or liquid detergent and rinsing with fresh water

thoroughly. **DO NOT** use abrasive cleansers or material as this may damage the surface.

SLATE CABINETS

Optional Slate cabinets are custom-built and painted in our factory. We recommend lightly brushing the cabinet with a SOFT bristle brush to remove any dirt or stains. For more information on the care of your Slate cabinet, please contact your Local Dealer.

COVER CARE

A well cared for spa cover is a thing of beauty in its own right. Be sure to clean and condition your cover at least once a month – more often if needed. Your cover needs to be cleaned and conditioned because vinyl can be dry and become brittle, spoiling your spa's appearance. Dry, brittle vinyl can also tear at the seams and stress points. Quality materials, internal sewn reinforcing and careful workmanship can only go so far against the ravages of Mother Nature. See the specific Warranty card enclosed with your cover for further details.

- When you shock your spa you need to remove the cover for a minimum of 30 minutes to ensure that the chemical gas off can escape from the spa.
- You are required to keep the spa covered at all time when not in use to protect the shell from harmful UV rays.
- A covered spa will use less electricity when maintaining the desired water temperature.
- See the manual that comes with the cover for proper mounting of the cover locks.
- The cover should remain locked at all times to prevent unauthorized entry into the spa and potential drowning.
- Do not Sit, Stand or Lie on your cover. Nor should you place any heavy object on top of the cover as this may damage the structure.

VERY IMPORTANT: We recommend a vinyl conditioner for your spa cover. Your local dealer carries a wide variety of care and maintenance products. Choose a pleasant day each month to remove your cover from the spa and lay it on a flat surface accessible by garden hose. Douse the cover with a healthy amount of water from the hose or a bucket to rinse away loose dirt or debris. Using a soft bristle brush and a mild solution of dishwashing liquid (about one teaspoon of detergent to two gallons of water), and with a gentle circular motion, scrub the cover clean. Be careful not to let any areas of the cover dry

before they're thoroughly rinsed. Now apply the vinyl conditioner as directed on the container. Massage the conditioner into the cover in a gentle but firm manner. Before replacing the cover on your spa, wipe and rinse any dirt from the bottom of the cover. When you are ready, put the cover on the spa.

NOTE: To remove tree sap, use lighter fluid (not charcoal lighter but the fluid used in cigarette lighters). Use sparingly, then immediately apply conditioner to that area.

All waterfalls and laminar flow water features should be turned off when the spa is not in use to avoid heat and water loss.



BASIC INSTALLATION AND CONFIGURATION GUIDELINES

WARNING! Qualified Technician Required for Service and Installation

ELECTRICAL REQUIREMENTS

All self contained spas use 120VAC or 240VAC electrical spa packs. These instructions describe the only acceptable electrical

wiring procedures. Spas wired in any other way will void your warranty and may result in serious injury. All installations should be completed by a certified electrician. Failure to comply with state and local codes may result in fire or personal injury and will be the sole responsibility of the spa owner.

120VAC: This requires an isolated 15 Amp circuit breaker. This needs to be an isolated circuit with no other appliances or lights on this circuit at any time. Extension cords are not to be used in conjunction with the operations of the spa. Low voltage damage could result and this is not covered by warranty.

NOTE: All components must be 120V; No 240V components allowable.

240VAC: Depending on the model of spa, it will require either a 40 Amp, 50 Amp, or 60 Amp dedicated circuit breaker, GFCI, with the proper wire size based on the length of the run. The electrical circuit must be installed by a certified electrician and approved by a local building or electrical inspector.

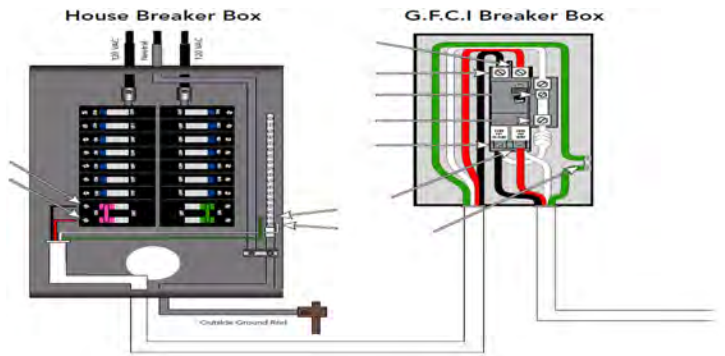

SWIM SPAS AMP CHART						
Series	Pumps	Voltage	Amperage	Frequency	Circuit Breaker	Max Flow Rate
Bench Series	1 x 4HP + 1 x 4HP Viper	240	40	60	50	91
Performance Series	2 x 4HP Viper + 1 x 5HP	240	40	60	50	91
Wellness Spa Series - 1400VE	2 x 4HP Viper + 1 x 5HP	240	40	60	50	91
Wellness Spa Series - 1700VE 2100VE 1600	3 x 4HP Viper + 1 x 5HP	240	48	60	60	91
Wellness Performance Plus (W/VSP)- 1400VE	1 x 5HP + 2 x VS	240	48	60	60	91
Wellness Performance Plus (W/VSP)- 1700 VE 2100 VE	1 x 5HP + 3 x VS	240	48	60	60	91

*Always use seimens breaker for Waterway packs. No Exception.

DISCLAIMER: There are no user serviceable parts in the GFCI compartment. All the services and repairs should be performed by a certified electrician only.

W^A{ q q ~ { AÎ OY ÔÁ&]]^AÁ& } a~ &f !•Á[]^ ÈÁ V[]~ ^Á-ajáÁ &}}^&ç }•Áàç ^} ÁGFÁæ áÁGHÁá Á|à•ÈÁÜ^æá Áæ&••æ|Á á& &}}^&ç *Á{ ^æ }•Áç Áà^Á }|çæ^áÁæÁç ÁÁ[-Áá•çææ] ÈÁ ÜÁ{ æ^ }ç^ &}}^&ç áÁ[, ^Á~]|^ ÈÁ

Ô[]^&ç]|^ Áç Áæ&æ æÁ]| ç&ç áÁ^ ÁæÁÖ|æ•ÁçÁÖ[]~ } áÁæè |çÁ Ôá& æÁçè||~ } çÁÁçÖÖÖÁ]|ÁÜ^•æ æÁÔ^ ||^ } çÁÔ^çæÁçÜÖÖÁ { []~ } çÁÁæ^æ çÁç ÈÈ GT DÁ]| { Áç/ç •æ^Á ç^ Á-ÁçÁ } ææ ááÁ |á^Á-Áæ @Á[{ ÁçÁ~ á { ^ } ç& }] æç ^ } çÁ

ÔÙÇÖP ÔŠU ÜWÜ ÒÁV'Y ÙÒÁÇÁ

Ü^Á^Áç Áç áá *Áæè]æ ç •æ^ÁçÁç ç^ Á-ÁçÁ }ç |Á } &[]~ |ÁÈ Ü^Á^Áç Áç çæææ } Áç áÁÜæç Áç•ç &ç }•Á]| çæ^áÁ^ ÁçÁ } çÁ { æ~ æç |ÁÈ

K 5FB-B; 'ÖÖÖÇÁ:ÜÖÖÁÜ] ç&ç } ÈÁ

V@ÁÜ, ^Á^Áç |áÁ^•çæ áÁ^•ççÁçÖÖÖÇÁ:ÜÖÖÁÜ } Áæ^~ |æÁ áæ áÁç ÁçÁç Áç } &ç } ÈÁ

K 5FB-B; 'Ü@ & Áçæ æáÁç [Á^Á^ÁÜ^Áçææ^ÁÜæç ÈÁ

Ô[Á] çæç [] çÁççæ^Á-ÁçÁç }ç |Á }•ç { ÈÖ[] çæç []~ |Áçæ^Á]|Á^Áçæ^Á]~ æ áææ } Áç] Áçæ çæ & ÈÖ[]||, ÁçÁç, } ^çÁç æ^ çÁ]|, ^Á&}}^&ç } ç•ç &ç }•Èç çæææ } Á~ çÁçÁç]|~ |^áÁ^ÁçÁç }•áÁ^Áççææ Áç áÁçÁç^]|~ } áá *Á&}}^&ç }•Á { ~ çÁà^Á]|] ^]| Áç •çæ^áÁçÖá &}}^&ç ÁçÁçÁççÁç, ^Áç^]|Á^Áççæ * ÈÁ S^] Áæ&••Áç []Áç]•áÈÁ

ÔÙÇÖT ÜŠÖÈ ÖÒÁ

751 HCB. '

- V^•ççÁç]|~ } áÁæè |çÁ&æ æÁ ç||~ } çÁÁç^]|Á^æç^•Áç-Áç •] æÈ
- Ü^ææÁç/ç•ç &ç } Á çæ^ æÈ
- ÇÁ~ æÁçææ æ^Áç ~ çÁçÁç]| çæ^áÁçÁçÁç~ á { ^ } çÁç Áç áá çæ^áÁç Áçæ ÈÈ

FOR USE ONLY WITHIN AN ENCLOSURE RATED CSA ENCLOSURE 3.

CONNECT ONLY TO A CIRCUIT PROTECTED BY A CLASS A GROUND FAULT CIRCUIT INTERRUPTER OR RESIDUAL CURRENT DEVICE.

TO ENSURE CONTINUED PROTECTION AGAINST SHOCK HAZARD, USE ONLY IDENTICAL REPLACEMENT PARTS WHEN SERVICING.

INSTALL A SUITABLY RATED SUCTION GUARD TO MATCH THE MAXIMUM FLOW RATE MARKED.

OPTIONAL AUXILIARY HEATER

Your spa (if opted) may be equipped with two heater assemblies (main heater and auxiliary heater). Auxiliary heater requires a separate 30 AMP breaker service.

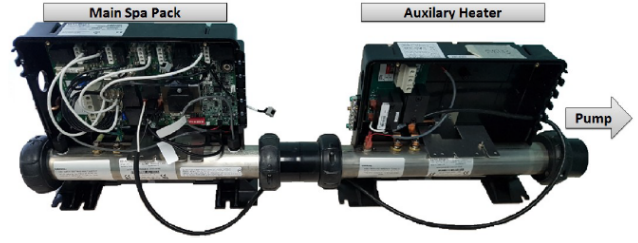

K 5FB-B; . '

- Y æ^Áç [] ^æè |Áç Áç&••Áç-Áç } ÖÁç æ ÁçÁç ç]á ~ •Áç ^]|ÁçæçÈ
- Ôá &}}^&ç Áç&ççÁç, ^Áç^]|Á^Áççæ * È

751 HCB. ' Y @ } Á~ á *Á ççÁ ^ÁçççÁ ^~ á { ^ } çÁ áæ çÁ çæç Áç&çç }•Áç |áçæ, æ^ÁçÁç ||, ^áÈÁ

GK =A 'GD5 'A5-BH9 B5 B79 'DFC798 I F9G'

ÖŠVÖÜÁ ÇÖVÖÇÈ ÖÒÁ

V@Á, á Áç ÁççÁçÁç }^Áç-ÁçÁç [•ç]|]ççç çç ç } ç&Á ç { •Áç-Áç } æÁV@ÁççÁçÁçÁçÁç [ç^ÁçáçÁç]| ÁçÁç, æÁçæ áÁ^Áç ÁçÁç } ÁçÁç^~ |æÁçæ á ÈÖæè]^Áç Áç Áç çÁç^ |ççÁç]|]Áç]|]| Áç ÁçÁç çæ çÁç]|áÁ]|^ç^ } çÁç } Áçææ * È Filtration starts as soon as flow is steady through the filter. As the filter cartridge removes the debris from the spa water, the accumulated debris causes flow resistance.

CLEANING AND REPLACING FILTER CARTRIDGE

Your swim spa filter has been designed for quick and easy maintenance. The filter cartridge should be rinsed by hose once a week and cleaned with a cartridge cleaner once a month. A second filter cartridge is recommended and will speed up this process. This can be purchased from your local dealer.



HCD'@58': =@HFG'

- Turn power OFF at the breaker.
- Loosen air relief valve, then remove retainer ring.
- Pull filter lid straight up to remove.
- Do not twist or pull the filter lid up on an angle. This could cause damage to the filter canister, especially in freezing conditions.
- ÚÀ [ÇÁÁÇ:Á&ædæ*^Áæ) áÁ&^æ) Á æðææ* æáá) Á@•^Áæ) áÁæ @ @]!••^ÁÁ [: : |ÉÚÁá áææ] Á [~ Á æ Á ^áÁÁ Á [æ Á [~ : ÇÁÁ Á á Á æ %æædæ*^Á ÇÁÁ Á &^æ) Á + Á Ç Á [ÇÁÁ ^æ&•• { á Á æ Á æ) áá Á á É
- Úá•^ÁÇ:Á@Ç:| ~ * @ ÁáÇ:| ÁÁá •æá) *ÉÖ|æ) ÁÚÉá *Á [ÁÇ:| |æ æ) áÁæ) | ÁáÁá @ÁÇ:| Á [-Á Çá] ^Á| á ææ) áá Á @ÁÚÉá *É Ö|Á [ÇÁÁ ^æ) Á Ç:| Ç:| Éæ^áÁ | á ææ) á æ Á á Á & ~ |á áá æ ^Á@Á ÚÉá *ÉÖ|) ~ |Ç:| ~ ÁÁáÇ:| Á Á ~ | &æ^Á ~ ææ| Ç:| á ææ) É
- Úææ^Áæ) Áædæ*^ÁÇ:| Áæ) á Ç:| É
- ÚÁ |ææ^ÁÇ:| Áæ) á Á ^Éæ @) Á ^ææ) á Á á *ÁÇ:| *ÁÇ:| *ÁÇ:| @ [] | D BCH9. T æ Á Á ^Á @Á Á ÚÉá *Á á Á [] Á @Á æ | Á ÇáÇáÉ æ) á Á á á *Á Á Ç @Á] | á Á Ç Á •ææ) *Á @] ~ [] ÉÚ@Á ÚÉá *Á • @ ~ |á] Á á ææ] ÁáÁ^| á ææ) á Á, æðææ •ææ] ^Á á ææ) É
- V@^ÁÁ ÁáÁ ÁáÁ ÁáÁ ÁáÁ [á *Á [{ Á@ÁÇ:| ÁáÁ ááÁ @ *Á • Ç Á @Á á [Ç:| { Á & !} Á Á [-Á @Á •] æ Á V@Á á ææ) • Á æ) @Á æ Á [{ æ }] áá@ÁÇ:| Áæ) á Ç:| É
- V@Á á Áá * [| ááÇ:| ÁÁÇ:| Á&@&Á@Á • á [^ Ááæ ^ááÇ:| á * • á [^ Á á [| ÁÇ:| ÁáÁ, ááÁæ) á Á } • & ^, Ááæ ^ááÇ:| á Á [Ç:| á á á á Áæ) á Á á •ææ] É

WATER QUALITY MAINTENANCE

Maintaining the quality of the water within the specified limits will serve to enhance your enjoyment and prolong the life of the swim spa's equipment. It is a fairly simple task, but it requires regular attention because the water chemistry involved is a balance of several factors. There is no simple formula, and there is no avoiding it. An indifferent approach to water maintenance will result in poor and potentially harmful conditions for soaking and even damage to your spa investment. The most important thing to keep in mind is that preventing poor water chemistry is much easier than correcting poor water chemistry. For specific guidance on maintaining water quality, consult your Authorized Dealer who can recommend appropriate chemical products for sanitizing and maintaining your swim spa.

MAINTAIN HEALTHY SPA WATER

Important! When maintaining your swim spa's water chemistry, ensure that your cover is removed during any aggressive treatments to allow for dissipation into the air. Take care to remove the cover slowly and

chemicals deplete if you are uncertain if your water is properly balanced. Always maintain your swim spa's water chemistry within the following parameters:

pH: pH is a measure of relative acidity or alkalinity of water and is measured on a scale of 0 to 14. The midpoint of 7 is said to be neutral, above which is alkaline and below which is acidic. In swim... [The rest of the text in this block is garbled and appears to be a mix of English and non-sensical characters.]

Calcium Hardness: This is a measurement of dissolved calcium in the water. Calcium will help control the corrosive nature of the swim spa's water. Á

keep your pH in the appropriate range thereby lessening the need for pH balancing. If the TA is too low the pH level will fluctuate rapidly from high to low. If the TA is too high the pH will tend to be too high and will be very difficult to bring back down.

Calcium Hardness: This is a measurement of dissolved calcium in the water. Calcium will help control the corrosive nature of the swim spa's water. Á



Look for these specialized cleaning attachments at your local dealership.

WARNING: Never store chemicals inside the equipment area of your swim spa.

IMPORTANT: Do not use Hydrogen Peroxide based sanitizers in your swim spa. When using Chlorine or Bromine tablets you must use a floating dispenser. These chemicals can have an extremely corrosive effect on certain materials in the swim spa. Damage caused by use of these chemicals, or improper use of any chemicals, is not covered under the spa limited warranty.

CH<9F 588 HJ9G. Many other additives are available for your swim spa. Some are necessary to compensate for out-of-balance water, some aid in cosmetic water treatment and others simply alter the feel or smell of the water. Your Authorized Dealer can advise you on the use of these additives.

ÖQ ÖÜ VÖÜ ÁT ÖÐ VÖP ÖÐ ÖÖÁ

751 HC.B. V } ; Á [~Á@Á•} ÁÁ+ [{ Á { æ Á Ö Ö Ö Á : ^ æ ^ Á à ^ - † ; ^ Á æ æ ; ^ * ^ ~ ö æ ^ Á æ æ ö } æ & Á | [& ^ ~ ^ • Æ

8 ð 9FH9F A5 BH9B5 B79 ÆGHFI 7 HC.BG`

1. Pull the diverter cap off and rotate the diverter body counter clock wise and pull out the assembly (Picture 1a to 1c).
2. Using clean piece of cloth, remove the dust particles or depositions (Picture 2).
3. Assemble the diverter body by inserting the body back by rotating the jet body clock-wise (Picture 3a). Attach the diverter cap (Picture 3b).

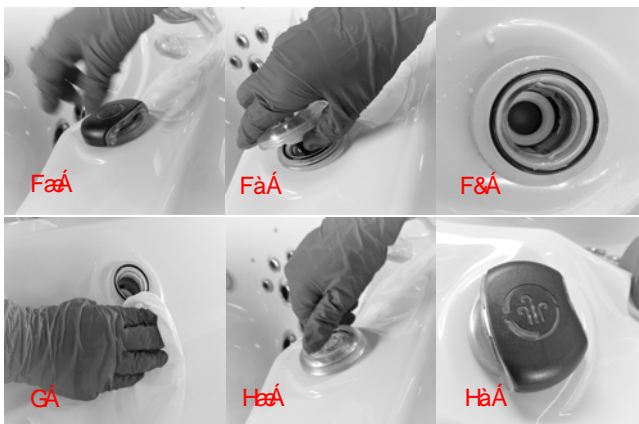

RÖVÁT ÖÐ VÖP ÖÐ ÖÖÁ

751 HC.B. Turn off the spa from main GFCI breaker before carrying out any maintenance procedures.

It is important to regularly clean the jets to prevent any unwanted depositions and potential damage to the plumbing. It is the responsibility of the customer to regularly perform the maintenance procedures. To clean and maintain optimum jet functions, follow the maintenance instructions below.

Ö A-B5F : ÖCK >9H'A5-BH9B5 B79 ÆGHFI 7HC.BG`

1. Ü [öæ Á & } } ö ! Á & [& Á , ä ^ Á æ ä Á } ~ || Á [~ ö Á @ Á ö Á à [ä ^ ÖÜ æ ö ! ^ Á Á æ ä Á Á F à Æ
2. W ä * Á & ^ æ ä Á ä & Á Á Á | ö Ö Á { [ç ^ Á ö Á ä ~ ö } æ æ ^ Á : ä ^ [• ä æ } • ÖÜ æ ö ! ^ Á Æ
3. Ü ^ { [ç ^ Á ö Á } ; ^ æ ö ä | ^ Á ä à ä Á ä ö ö Á ö | Á Á Á æ ~ { & ^ æ ^ ! Á ÖÜ æ ö ! ^ Á Æ
4. Ö • ^ { à | ^ Á ö Á ö Á ä • ^ ! ö ä æ Á à Á | ö æ * Á ö Á ö Á à [ä ^ & [& Æ ä ^ Á ÖÜ æ ö ! ^ Á æ ä Á à Æ

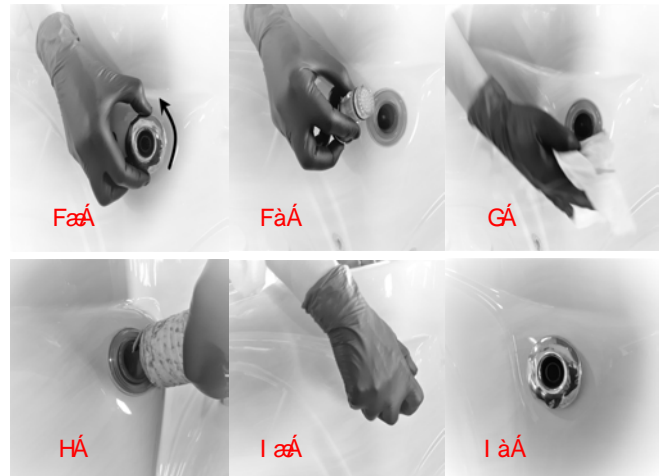

WATER CLARITY TROUBLESHOOTING

PROBLEM	PROBABLE CAUSE	POTENTIAL SOLUTIONS
Water Odor	<ul style="list-style-type: none"> • Improper sanitization • Excessive organics in water • pH is too low 	<ul style="list-style-type: none"> > Add sanitizer > Shock swim spa with sanitizer > Adjust pH
Chlorine Odor	<ul style="list-style-type: none"> • Chloramines are too high • pH is too low 	<ul style="list-style-type: none"> > Shock swim spa with sanitizer > Adjust pH
Musty Odor	<ul style="list-style-type: none"> • Bacteria or Algae growth 	<ul style="list-style-type: none"> > Shock swim spa with sanitizer > Drain and refill swim spa water
Scale	<ul style="list-style-type: none"> • Total alkalinity is too high • pH is too high • High calcium content in water 	<ul style="list-style-type: none"> > Adjust total alkalinity > Adjust pH > Use stain and scale product
Stains	<ul style="list-style-type: none"> • Total alkalinity is too low • pH is too low • High metal content in water 	<ul style="list-style-type: none"> > Adjust alkalinity > Adjust pH > Use stain and scale product
Cloudy Water	<ul style="list-style-type: none"> • Poor filtration • pH is too high • Hardness is too high • Total alkalinity is too high • Suspended particles 	<ul style="list-style-type: none"> > Clean filter cartridge > Adjust pH > Adjust hardness > Adjust total alkalinity > Drain and refill swim spa water
Algae Growth	<ul style="list-style-type: none"> • pH is too high • Sanitizer is too low 	<ul style="list-style-type: none"> > Adjust pH > Shock swim spa with sanitizer > Adjust sanitizer level
Eye Irritation	<ul style="list-style-type: none"> • pH is too low • Sanitizer is too low 	<ul style="list-style-type: none"> > Adjust pH > Shock swim spa with sanitizer > Adjust sanitizer level
Skin Rash/Irritation	<ul style="list-style-type: none"> • Free chlorine level too high • Unsanitary water 	<ul style="list-style-type: none"> > Adjust chlorine level > Shock swim spa with sanitizer > Adjust sanitizer level

CAUTION: Please follow the manual instructions carefully to troubleshoot the spa. Turn of the spa from main GFCI breaker to prevent electrical shock. All the repairs **MUST** be performed by a certified electrician only.

TROUBLESHOOTING GUIDE

SWIM SPA SYSTEM

SYMPTOM	PROBABLE CAUSE	RECOMMENDED ACTION
Swim Spa does not work	<ul style="list-style-type: none"> Power is turned off 	<ul style="list-style-type: none"> > Reset GFCI
No display on the control panel	<ul style="list-style-type: none"> Power is turned off Defective control panel 	<ul style="list-style-type: none"> > Reset GFCI > Contact your Dealer
Letters on the control panel	<ul style="list-style-type: none"> An error has been found 	<ul style="list-style-type: none"> > Refer to the Reference Card for your control panel to verify the error. Contact your Dealer for service.

PUMP PROBLEMS

SYMPTOM	PROBABLE CAUSE	RECOMMENDED ACTION
Noisy/Loud motor	<ul style="list-style-type: none"> Air trapped in the pump Low water level Worn pump seal Defective pump 	<ul style="list-style-type: none"> > Open bleed valve in the skimmer > Add water to the spa > Contact your Dealer > Contact your Dealer
Pumps power down on their own	<ul style="list-style-type: none"> Set temperature has been reached Filtration cycle has ended Automatic time out Overheat safety protection 	<ul style="list-style-type: none"> > No problem > No problem > Pumps are set to run for a predetermined time while the swim spa is in use (15-20 Mins) > The pumps have a thermal overload which will prevent them from running for extended periods of time. Wait until pumps have cooled down (1+ hrs). If problem persists, contact your Dealer.
Pump running constantly, will not turn off	<ul style="list-style-type: none"> Filter cycle set to 24 hours Problem with the circuit board 	<ul style="list-style-type: none"> > Turn off 24 hour filtration > Turn power off at GFCI and contact your Dealer
Pump will not turn on	<ul style="list-style-type: none"> GFCI tripped Motor has overheated Not plugged in Damaged plug Seized motor Blown fuse Motor vent is blocked 	<ul style="list-style-type: none"> > Reset the GFCI > Let cool for 1+ hour > Plug in to the board > Contact your Dealer > Contact your Dealer > Check fuse or contact your Dealer > Clear debris from the vent

CAUTION: Please follow the manual instructions carefully to troubleshoot the spa. Turn of the spa from main GFCI breaker to prevent electrical shock. All the repairs MUST be performed by a certified electrician only.

HEAT PROBLEMS	PROBABLE CAUSE	RECOMMENDED ACTION
Water will not heat	<ul style="list-style-type: none"> • Error message on control panel • Swim spa is in a different Heat Mode • Water level is too low • Poor water flow • Closed valves • Pump 1 is not running 	<ul style="list-style-type: none"> > Refer to the Reference Card for your control panel to verify the error > Set swim spa to "Standard Mode" > Add water to the spa > Clean filter & check valves > Open all valves > Contact your dealer
Water is too hot	<ul style="list-style-type: none"> • Incorrect reading • Filter cycle duration is too long • Pump speeds reversed 	<ul style="list-style-type: none"> > Verify temperature with thermometer > Reduce duration of the filter cycle > Contact your dealer
Water will not maintain heat	<ul style="list-style-type: none"> • Cover is off for extended periods of time in cold weather / cold wind. • Swim spa is wired for 110V and jets are on. 	<ul style="list-style-type: none"> > Put cover back onto swim spa and allow for heat to regenerate. Call your dealer if temperature does not increase. > Swim spa wired for 110V only have enough power to heat or operate pumps. Turn off jets to power heater.
LIGHTING ISSUES	PROBABLE CAUSE	RECOMMENDED ACTION
Standard light will not come on	<ul style="list-style-type: none"> • Bulb has burnt out 	<ul style="list-style-type: none"> > Replace the light bulb
LED lighting not in sync	<ul style="list-style-type: none"> • Burnt out bulb/connection 	<ul style="list-style-type: none"> > Contact your dealer
LED lighting won't come on	<ul style="list-style-type: none"> • Incorrect settings 	<ul style="list-style-type: none"> > Contact your dealer
PUMPS WILL NOT PRIME	PROBABLE CAUSE	RECOMMENDED ACTION
Pump on but no water flow	<ul style="list-style-type: none"> • Air trapped in pump • No water in the pump • Closed valves 	<ul style="list-style-type: none"> > Loosen bleed valve in skimmer > Check the fill level in the swim spa > Open all valves
HYDROTHERAPY JETS	PROBABLE CAUSE	RECOMMENDED ACTION
Little to no water flowing from jets	<ul style="list-style-type: none"> • Jets turned off • Pump not primed • Valves are closed • Diverter set to a different seat • Dirty filter 	<ul style="list-style-type: none"> > Open jet by turning the face counter clockwise > Reset breaker to allow for the spa to prime the pump. Open bleed valve in the skimmer area. > Open valves > Switch diverter > Remove and clean filter cartridge
PLUMBING SYSTEM	PROBABLE CAUSE	RECOMMENDED ACTION
Water around base of spa	<ul style="list-style-type: none"> • Loose connections • Leak from internal fitting 	<ul style="list-style-type: none"> > Hand tighten all quick disconnects and fittings. > Check gaskets and O-rings > Contact your dealer

CAUTION: Please follow the manual instructions carefully to troubleshoot the spa. Turn of the spa from main GFCI breaker to prevent electrical shock. All the repairs MUST be performed by a certified electrician only.

DRAINING AND WINTERIZING

DRAINING YOUR SPA

After a period of 3-4 months, detergent residues from bathing suits and soap film will build up in your spa water. Once this happens, your swim spa water will appear cloudy and should probably be replaced.

- Turn power OFF at the breaker.
- Locate the drain valve (usually in the equipment area).
- Remove the safety cap and attach garden hose.
- Drain water to a convenient area. (Swim spa water may harm grass or plants if sanitizer levels are high.)
- When water begins to flow out of the hose, open the air relief valve located on filter lid (Hydro-Cyclonic Filtration) or Air Bleeder Valve (Skim Filtration).
- Your swim spa will drain except for a small portion left in the foot well. This can be removed with a sponge and pail.
- Once empty, clean as required.
- To finish, remove garden hose and attach safety cap.

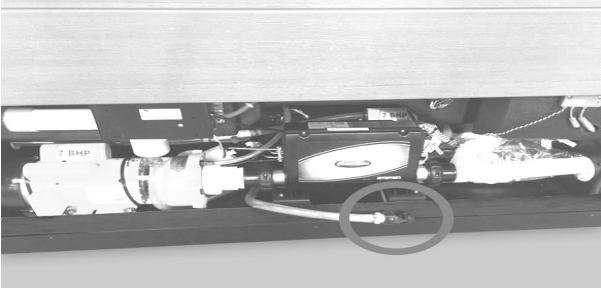

WINTERIZING YOUR SPA

In many areas of the world the temperature may drop below 32°F (0°C). We recommend the swim spa is always filled with water and running at normal spa temperatures. By doing this you will minimize the risk of freezing within your swim spa. If it is necessary to leave your swim spa unattended for long periods of time during cold weather conditions, you should drain your swim spa to avoid accidental freezing caused by power outages.

Your local dealer can perform the following winterizing procedures, if you are not completely comfortable with them.

- Ensure that you have fully drained the swim spa (Refer to the DRAINING YOUR SPA section).
- After draining, your swim spa may still have water remaining in the equipment and plumbing fittings. Disconnect the hand-tightened union fittings going to and from the jet pumps. Be careful not to lose the O-rings between the unions and pump housing.

- Leave drain valve in the open position and safety cap off .
- To completely drain the plumbing lines, a wet/dry shop vacuum can be used to draw out any remaining water. Place the vacuum hose over the jet fittings in the swim spa as well as the plumbing lines in the equipment area. You should also disconnect the plug on the crystal clear inspection tube (if installed).
- Remove the filter cartridge and store in a warm, dry area.
- Clean the swim spa shell and place spa cover on spa. Be sure to lock the cover in place in case of high winds or rain.

WARNING: The instructions above should be followed accordingly when winterizing your swim spa however they are guidelines and potential freeze damage may still occur. All freeze damage is the sole responsibility of the swim spa owner and will not be covered by the warranty should it occur.

EMERGENCY SITUATIONS: To eliminate freezing in the event of equipment failure, use a 100-watt light bulb or small heater via extension cord and place it in the equipment area, keeping it away from plumbing lines. This will help for a short period of time until proper service can be rendered.



DRAINING INSTRUCTIONS

1. On the control panel (settings) select **hold**. This will suspend all functions so that the spa can start to be drained.
2. Remove the false bottom in cabinet area.
3. Connect your hose to the hose bib located in the lower compartment. Open the hose bib valve until water starts coming out of the drain hose.
4. Turn evacuation pump power switch ON - located at the top left of the enclosure.
5. The length of time it will take to drain depends on the size of your spa. On average it will take approximately 1 hour.

If you have an Infinity Edge Spa allow it to drain for 30 minutes and then take it off of **hold**. Pump 1 will run on low speed to drain the tank into the main body of the spa.

Let pump 1 run on low speed until the water stops coming out of the jets/waterfall and immediately put the system back into **hold** (refer to step one).

6. Allow spa to finish draining. When fully drained, switch off the evacuation pump and close the hose bib valve.
7. Switch off power to the spa via the main GFCI Breaker.
8. You may have to use a shop vacuum to remove any excess water. Clean the spa before refilling. Refer to your Owner's Manual for proper filling instructions. Once the spa is filled, **prior to adding chemicals**, open the hose bib valve for approx. 15 seconds to allow fresh water to flush the Water-Vac™ System then close the hose bib valve.

IMPORTANT PLEASE READ

Do not leave your spa unattended while draining. After 90 minutes the hold function is disabled and will allow your spa pumps to activate. This could cause damage to your equipment.

SWIM SPA POOL SERIES CONTROL PANEL

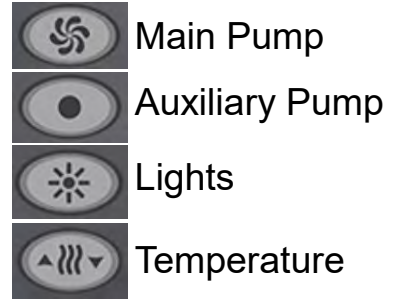

INITIAL START-UP

Your swim spa will enter Priming Mode (PR) when it is energized. During Priming Mode, press “Jets” button repeatedly and be sure the pump is free of air. Priming Mode lasts less than 5 minutes. Press “Warm” or “Cool” to exit. After Priming Mode, the swim spa will run in Standard Mode (see Mode section).

TEMP CONTROL

(80°F - 104°F / 26°C - 40°C)

The last measured water temperature is constantly displayed. The water temperature displayed is current only when the pump has been running for at least 1 minute. To display the set temperature, press “Temp” once. To change the set temperature, press the temperature button again before the display stops flashing and hold. The set temperature will begin to rise, release the button at the desired set temperature. To decrease the set temperature, press and hold the “temp” button again and the set temperature will decline, release at the desired set temperature. After three seconds, the display will stop flashing and begin to display the current swim spa temperature. The swim spa will then begin heating (or cooling) in order to reach the set temperature that you have selected.

PUMP

Press “Pump” to turn the pump on or off, and to shift between low and high speeds (if equipped). If left running, the pump will turn off after a preset length of time. Low speed may run automatically at times as part of your spas filtration cycles, during which it cannot be deactivated from the panel, however you will still be able to control the high speed setting. The ozone generator (if installed) will activate anytime low speed is running.

AUX (PUMP 2)

If an additional pump or blower is installed. Press “Aux” to turn the device on. If your additional device is a dual speed pump, pressing “Aux” again will activate the pumps high speed. Pressing “Aux” again will turn off the device/pump.

LIGHT

Press “Light” to operate the swim spa light. Turns off after 4 hours. If your swim spa is equipped with a multicolor lighting package, then pressing the “Light” button consecutively will toggle the lights through different colors modes.

MODE

Mode is changed by pressing “Temp” then “Light”. Continue Pressing the “Temp” then “Light” button to toggle through the available modes. Leave the control for 10 seconds to exit.

Standard Mode maintains set temperature. “St” will be displayed momentarily when you switch into Standard Mode.

Economy Mode heats the swim spa to the set temperature only during filter cycles. “Ec” will display when water temp is not current, and will alternate with water temp when the pump is running.

Sleep Mode heats the swim spa to within 20°F/10°C of the set temperature only during filter cycles. “SL” will display when water temp is not current, and will alternate with water temp when the pump is running.

PRESET FILTER CYCLES

The first preset filter cycle begins 6 minutes after the swim spa is energized. The second preset filter cycle begins 12 hours later. Filter duration is programmable for 1, 2, 3, 4, 5, 6, 7, or 8 hours. The default filter time is 1 hour. To program, press “Temp,” then “Jets.” Press “Temp” to adjust. Press “Jets” to exit programming.

DIAGNOSTIC MESSAGES

SYMPTOM	PROBABLE CAUSE	RECOMMENDED ACTION
	No message on display. Power has been cut off to the spa.	The control panel will be disabled until power returns. Swim spa settings will be preserved until next power up.
--	Temperature unknown.	After the pump has been running for 2 minutes, the current water temperature will be displayed.
HH	"Overheat" - The spa has shut down.* One of the sensors has detected 118°F/47.8°C at the heater.	DO NOT ENTER THE WATER. Remove the swim spa cover and allow water to cool. Once the heater has cooled, reset by pushing any button. If the swim spa does not reset, shut off the power to the swim spa and call your dealer for service organization
OH	"Overheat" - The swim spa has shut down.* One of the sensors has detected that the swim spa water is 110°F/43.5°C.	DO NOT ENTER THE WATER. Remove the swim spa cover and allow water to cool. At 107°F/41.7°C, the swim spa should automatically reset. If swim spa does not reset, shut off the power to the swim spa and call your dealer or service organization
SA	Swim spa is shut down.* The sensor that is plugged into the Sensor "A" jack is not working.	If the problem persists, contact your dealer or service organization. (May appear temporarily in an overheat condition)
Sb	Swim spa is shut down.* The sensor that is plugged into the Sensor "B" jack is not working.	If the problem persists, contact your dealer or service organization. (May appear temporarily in an overheat condition)
Sn	Sensors are out of balance. If alternating with spa temperature, it may just be a temporary condition. If flashing by itself, swim spa is shut down.	If the problem persists, contact your dealer or service organization.
HL	A significant difference between temperature sensors has been detected. This could indicate a flow problem.	If the water level is normal, make sure all pumps have been primed. If problem persists contact your dealer or service organization.
LF	Persistent low flow problems. (Displays on the fifth occurrence of message within 24 hours.) Heater is shut down, but other swim spa functions continue to run normally.	Follow action required for (HFL) message. Heating capability of the swim spa will now reset automatically. You may press any button to reset.
dr	Possible inadequate water, poor flow, or air bubbles in detected in the heater. Swim spa is shut down for 15 minutes.	If the water level is normal, make sure all pumps have been primed. If problem persists contact your dealer or service organization.
dY	Inadequate water detected in heater. (Displays on third occurrence of message.) Swim spa is shut down.*	Follow action required for (dr) message. Swim spa will not automatically reset. Press any button to reset manually.
IC	"Ice" - Potential freeze condition detected. *Even when swim spa is shut down, some equipment will turn on if freeze protection is needed.	No action required. All equipment will automatically activate regardless of swim spa status. The equipment stays on 4 minutes after the sensors detect that the swim spa temperature has risen to 45°F/7.2°C or higher. An optional freeze sensor may be added to protect against extraordinary freeze conditions. Auxiliary freeze sensor protection is advisable for colder climates. See your dealer for details.

SWIM SPA PARTY SERIES CONTROL PANEL



Temperature Up



Temperature Down



Menu/Select



Light



Pump



Auxiliary

NAVIGATION

Navigating the entire menu structure is done with 2 or 3 buttons on the control panel. Some panels have separate UP and DOWN buttons, while others have a single Temperature button. In the navigation diagrams Temperature buttons are indicated by a single button icon. Panels that have two Temperature buttons (Up and Down) can use both of them to simplify navigation and programming where a single Temperature icon is shown. The MENU/SELECT Button is used to choose the various menus and navigate each section. Typical use of the Temperature button(s) allows changing the Set Temperature while the numbers are flashing in the LCD. The menus can be exited with certain button presses. Simply waiting for a few seconds will return the panel operation to normal.

PRIMING MODE

This mode will last for 4-5 minutes or you can manually exit the priming mode after the pump(s) have primed.

Regardless of whether the priming mode ends automatically or you manually exit the priming mode, the system will automatically start normal heating and filtering at the end of the priming mode. During the priming mode, the heater is disabled to allow the priming process to be completed without the possibility of energizing the heater under low-flow or no-flow conditions. Nothing comes on automatically, but the pump(s) can be energized by pushing the “Jets” or “Aux” buttons.

PRIMING THE PUMPS

As soon as the above display appears on the panel, push the “Jets” button once to start Pump 1 in low-speed and then again to switch to high-speed. Also, push the “Jets 2” or “Aux” button, if you have a 2nd pump, to turn it on. The pumps will now be running in high-speed to facilitate priming. If the pumps have not primed after 2 minutes, and water is not flowing from the jets in the swim spa, do not allow the pumps to continue to run. Turn off the pumps and repeat the process. **Note:** Turning the power off and back on again will initiate a new pump priming session. Sometimes momentarily turning the pump off and on will help it to prime. Do not do this

more than 5 times. If the pump(s) will not prime, shut off the power to the swim spa and call for service. **Important:** A pump should not be allowed to run without priming for more than 2 minutes. Under NO circumstances should a pump be allowed to run without priming beyond the end of the 4-5 minute priming mode. Doing so may cause damage to the pump and cause the system to energize the heater and go into an overheat condition.

DUAL TEMPERATURE RANGES

This system incorporates two temperature range settings with independent set temperatures. The High Range designated in the display by a thermometer and an “Up” arrow, and the Low Range designated in the display by a thermometer and “Down” arrow. These ranges can be used for various reasons, with a common use being a “ready to use” setting vs. a “vacation” setting. The Ranges are chosen using the menu structure below. Each range maintains its own set temperature as programmed by the user. This way, when a range is chosen, the swim spa will heat to the set temperature associated with that range.

For example:

- High Range might be set between 80°F and 104°F.
- Low Range might be set between 50°F and 99°F.

Changing the Temp Range:

Press and release the “Menu” button until “TEMP” is on the screen, Press and release the “Up” or “Down” button to adjust High Range “▲” or Low Range “▼”. Press and release the “Menu” button to save the Temp Range.

MODE – READY AND REST

IN ORDER FOR THE SPA TO HEAT, A PUMP NEEDS TO CIRCULATE WATER THROUGH THE HEATER. THE PUMP THAT PERFORMS THIS FUNCTION IS KNOWN AS THE “PRIMARY PUMP.”

If the primary pump is a 2-Speed Pump 1, Ready Mode (indicated by **R**) will circulate water periodically, using Pump 1

Low, in order to maintain a constant water temperature, heat as needed, and refresh the temperature display. This is known as "polling."

Rest Mode (indicated by) will only allow heating during programmed filter cycles. Since polling does not occur, the temperature display may not show a current temperature until the primary pump has been running for a minute or two.

In **Rest Mode**, the spa will only heat to set temperature during programmed filter times, even though the water is being filtered constantly when in Circulation Mode.

Changing the Mode:

Press and release the "Menu" button until "MODE" appears. Press and release the "Up" or "Down" button to switch the Mode to "Ready" or "Rest". Press and release the "Menu" button to save the selected mode.

READY-IN-REST

Mode appears in the display if the swim spa is in Rest Mode and "Jets" is pressed. It is assumed that the swim spa is being used and will heat to set temperature. The primary pump will run until set temperature is reached, or 1 hour has passed. After 1 hour, the System will revert to Rest Mode. This mode can also be reset by entering the Mode Menu and changing the Mode.

SHOW AND SET TIME-OF-DAY

Be sure to set the Time-of-Day Setting the time-of-day can be important for determining filtration times and other background features. When in the TIME menu, SET TIME will flash on the display if no time-of-day is set in the memory.

SETTING THE TIME:

Press and release the "Menu" button until "TIME" appears. Press and release the "Up" or "Down" to adjust the Hour. Press the "Menu" button to save the hour and move on to the Minutes. Press and release the "Up" or "Down" to adjust the Minutes. Press the "Menu" button to save the Minutes.

Note: If Time of Day is not actually programmed due to a power cycle, SET TIME will appear in the menu instead of just TIME.

HOLD (STANDBY)

Hold Mode is used to disable the pumps during service functions like cleaning or replacing the filter. Hold Mode will last for 1 hour unless the mode is exited manually.

Selecting Hold Mode:

Press and release the "Menu" button until "HOLD" is on the screen. Press and release the "Up" or "Down" button to activate "Hold

Mode". The screen will display HOLD, ING, FOR, and the time remaining.

FLIP (INVERT DISPLAY)

Invert the display.

Changing the Screen Orientation:

Press and release the "Menu" button until "FLIP" is on the screen. Press and release the "Up" or "Down" button to invert the display. Press and release the menu button to save this setting.

RESTRICTING OPERATION

The control can be restricted to prevent unwanted use or temperature adjustments.

Locking the panel prevents the controller from being used, but all automatic functions are still active. Locking the Temperature allows Jets and other features to be used, but the Set Temperature and other programmed settings cannot be adjusted.

Temperature Lock allows access to a reduced selection of menu items. These include Set Temperature, FLIP, UTIL, INFO and FALT LOG.

Restricting Operation:

Press and release the "Menu" button until "LOCK" is on the screen. Press and release the "Up" or "Down" button to enter the menu. Press and release the "Menu" button to switch from "TEMP" to "PANL". **Note:** Pressing and releasing the "Menu" button again will take you back to the beginning of the "LOCK" menu. With "TEMP" or "PANL" selected press and release the "Up" or "Down" button to change the menu selection to the "OFF"/"ON" option. Press and release the "Up" or "Down" button to change the menu option from "OFF" to "ON" to lock either the "TEMP" to "PANL". Press and release the "Menu" button to save the "LOCK" setting.

UNLOCKING

This Unlock sequence may be used from any screen that may be displayed on a restricted panel.

Unlocking instructions:

While pressing and holding the Temperature Button (UP button or Up button), slowly press and release the "Menu" button two times.

ADJUSTING FILTRATION

Filter cycles are set using a start time and a duration. Start time is indicated by an "A" or "P" in the bottom right corner of the display. Duration has no "A" or "P" indication. Each setting

can be adjusted in 15-minute increments. The panel calculates the end time and displays it automatically.

How to adjust the Filtration:

Press and release the "Menu" button until "FLTR" 1 or 2 appear on the screen. Press and release the "Up" or "Down" button to enter the menu, "BEGN" should appear. Press and release the "Up" or "Down" button to set the start time (Option 1) or Press and release the "Menu" button to set the duration (Option 2).

Pressing and releasing the "Menu" Button again during the "RUN"- "HRS" will display which filter cycle is being set and the end time. Press and release the "Menu" once more to save the settings.

Option 1: Setting the Start Time

With "BEGN" on the screen press and release the "Up" or "Down" button, use the "Up" or "Down" buttons to adjust the starting hour. When satisfied press the "Menu" to proceed to the Minutes. Use the "Up" or "Down" buttons to adjust the starting Minutes. When complete press the "Menu" button to save the starting time.

Option 2: Setting the Duration

With "BEGN" on the screen press and release the "Up" or "Down" button to set the starting time (Option 1, please see above) or press the "Menu" button to proceed to "RUN"- "HRS". Use the "Up" or "Down" buttons to adjust the hours of duration. Press the "Menu" button to start the minutes. Use the "Up" or "Down" buttons to adjust the duration minutes. When complete press the "Menu" button to save the duration time.

Filter Cycle 2 - Optional Filtration

Filter Cycle 2 is OFF by default. It is possible to overlap Filter Cycle 1 and Filter Cycle 2, which will shorten overall filtration by the overlap amount.

Purge Cycles

In order to maintain sanitary conditions, secondary Pumps and/ or a Blower will purge water from their respective plumbing by running briefly at the beginning of each filter cycle. If Filter Cycle 1 is set for 24 hours, enabling Filter Cycle 2 will initiate a purge when Filter Cycle 2 is programmed to begin.

ADDITIONAL INFORMATION

PREFERENCES:

Press and release the "Menu" button until "PREF" appears. Press and release the "Up" or "Down" button to enter the Preferences menu. Use the "Menu" button to scroll through the options (listed ahead) and the "Up" or "Down" buttons to enter that section. While

in a section use the "Up" or "Down" buttons to toggle the options and the "Menu" button set each option in the memory.

F / C (Temp Display)

Change the temperature between Fahrenheit and Celsius.

12 / 24 (Time Display)

Change the clock between 12 hr and 24 hr display.

RE-MIN-DERS (Reminders)

Turn the display of reminder messages (like "Clean Filter") On or Off. **Note:** Reminders continue to run in the background even when not displayed. So turning the display of Reminders On or Off does not reset any Reminder counts.

CLN-UP (Cleanup)

Cleanup Cycle Duration is not always enabled, so it may not appear. When it is available, set the length of time Pump 1 will run after each use. 0-4 hours are available.

M8

(This message may not appear on all systems.) On systems that have M8, it is enabled by default. It can be disabled (or re-enabled) here. M8 reduces polling intervals when the water temperature in the spa is steady.

DOL-PHIN-AD-DRES (Dolphin II and Dolphin III)

Applies to RF Dolphin only. (This message may not appear depending on the configuration) When set to 0, no addressing is used. Use this setting for a Dolphin Remote which is factory set for no address by default. When set between 1 and 7, the number is the address. (See the Dolphin manual for details.)

UTILITIES AND INFORMATION

Press and release the "Menu" button until "UTIL" appears. Press and release the "Up" or "Down" button to enter the Preferences menu. Use the "Menu" button to scroll through the options (listed ahead) and the "Up" or "Down" buttons to enter that section. While in a section use the "Up" or "Down" buttons to toggle the options and the "Menu" button set each option in the memory.

INFO (System Information sub-menu)

The System Information Menu displays various settings and identification of the particular system.

SSID (Software ID)

Displays the software ID number for the System. MODL (System Model) Displays the Model Number of the System.

SETP (Current Setup) Displays the currently selected Configuration Setup Number.

Heater Voltage (Feature not used on CE rated systems.)

Displays the operating voltage configured for the heater.

Heater Wattage as Configured in Software (CE Systems Only.)

Displays a heater kilowatt rating as programmed into the control system software (1-3 or 3-6).

H _ (Heater Type)

Displays a heater type ID number.

SW _ (Dip Switch Settings)

Displays a number that represents the DIP switch positions of S1 on the main circuit board.

PANL (Panel Version)

Displays a number of the software in the control panel.

GFCI (GFCI Test)

(Feature not available on CE rated systems.)

GFCI Test is not always enabled, so it may not appear. This screen allows the GFCI to be tested manually from the panel and can be used to reset the automatic test feature. If the GFCI Test Feature is reset, the device will trip within 7 days.

A / B (A/B Sensor Temperatures)

When this is set to On, the temperature display will alternate to display temperature from Sensor A and Sensor B in the heater.

FALT LOG (Fault Log)

The Fault Log is a record of the last 24 faults that can be reviewed by a service tech.

DEMO (Demo Mode)

Demo Mode is not always enabled, so it may not appear. This is designed to operate several devices in a sequence in order to demonstrate the various features of a particular swim spa.

SWIM SPA PERFORMANCE/WELLNESS SERIES CONTROL PANEL



The Main Menu

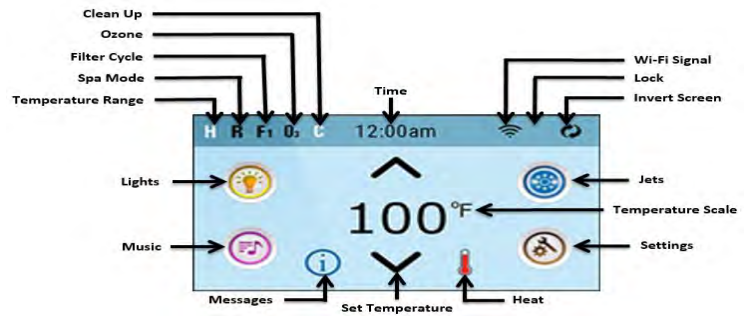

PRIMING THE PUMPS

As soon as the Priming Mode screen appears on the panel, select the “Jets 1” button once to start Pump 1 in low-speed and then again to switch to high-speed. Also, select the other pumps, to turn them on. The pumps should be running in high-speed to facilitate priming. If the pumps have not primed after 2 minutes, and water is not flowing from the jets in the spa, do not allow the pumps to continue to run. Turn off the pumps and repeat the process. **Note:** Turning the power off and back on again will initiate a new pump priming session. Sometimes momentarily turning the pump off and on will help it to prime. Do not do this more than 5 times. If the pump(s) will not prime, shut off the power to the spa and call for service. **Important:** A pump should not be allowed to run without priming for more than 2 minutes. Under NO circumstances should a pump be allowed to run without priming beyond the end of the 4-5 minute priming mode. Doing so may cause damage to the pump and cause the system to energize the heater and go into an overheat condition.

EXITING PRIMING MODE

The system will automatically enter the normal heating and filtering at the end of the priming mode, which lasts 4-5 minutes. You can manually exit Priming Mode by pressing the “Exit” button on the Priming Mode Screen. Note that if you do not manually exit the priming mode as described above, the priming mode will be automatically terminated after 4-5 minutes. Be sure that the pump (s) have been primed by this time. Once the system has exited Priming Mode, the top-side panel will display the Main Screen, but the display will not show the temperature yet, as shown below. This is because the system requires approximately 1 minute of water flowing through the heater to determine the water temperature and display it.

NAVIGATION

Navigating the entire menu structure is done by touching the screen. When a text item is shown in white on the main screen, it

is selectable. The menu selections on the right side of the screen can be selected. Select one of these to enter a different screen with additional controls. Most menu screens time out and revert to the main screen after 30 seconds of no activity. The only item that can be changed on the left side of the Main Screen is the Set Temperature. Touch either the set temperature line or the water temperature to go to the Set Temperature screen.

TIME-OF-DAY

Be sure to set the Time-of-Day

Setting the time-of-day is important for determining filtration times and other background features. “Set Time” will appear on the display if no time-of-day is set in the memory. On the Settings Screen, select the Time-of-Day line. On the Time-of-Day screen, simply select the Hour, Minutes, and 12/24 Hour segments. Use the Up and Down Buttons to make changes. **Note:** This only applies to some systems: If power is interrupted to the system, Time-of-Day will be maintained for several days.

JETS

The Spa Screen shows all available equipment to control, as well as other features, like Invert. The display shows icons that are related to the equipment installed on a particular spa model, so this screen may change depending on the installation. The icon buttons are used to select and control individual devices. Some devices, like pumps, may have more than one ON state, so the icon will change to reflect the state that the equipment is in. Below are some examples of 2-speed Pump indicators.

If the Spa has a Circ Pump, a Circ Pump Icon will appear to indicate its activity, but outside of Priming Mode, the Circ Pump cannot be controlled directly.

Note: The icon for the pump that is associated with the heater (Circ or P1 Low) will have a red glow in the center when the heater is running.

SETTINGS

The Settings Screen is where all programming and other spa behaviors are controlled. This screen has several features that can be acted on directly. These features may include Temp Range, Heat Mode, Hold, and Invert Panel. When one of these items is selected, it will toggle between two settings. All other menu items (with an arrow pointing to the right) go to another level in the menu.

DUAL TEMPERATURE RANGES (HIGH VS. LOW)

This system incorporates two temperature range settings with independent set temperatures. The specific range can be selected on the Settings screen and is visible on the Main Screen in the upper right corner of the display. These ranges can be used for various reasons, with a common use being a “ready to use” setting vs. a “vacation” setting. Each range maintains its own set temperature as programmed by the user. This way, when a range is chosen, the spa will heat to the set temperature associated with that range.

- High Range can be set between 80°F and 104°F.
- Low Range can be set between 50°F and 99°F.

HEAT MODE – READY VS. REST

In order for the spa to heat, a pump needs to circulate water through the heater. The pump that performs this function is known as the “heater pump.” The heater pump can be either a 2-speed pump (Pump 1) or a circulation pump. If the heater pump is a 2-Speed Pump 1, Ready Mode will circulate water every 1/2 hour, using Pump 1 Low, in order to maintain a constant water temperature, heat as needed, and refresh the temperature display. This is known as “polling.” Rest Mode will only allow heating during programmed filter cycles. Since polling does not occur, the temperature display may not show a current temperature until the heater pump has been running for a minute or two. When the heater pump has come on automatically (for example for heating) you can switch between low speed and high speed but you cannot turn the heater pump off.

RESTRICTING OPERATION

The control can be restricted to prevent unwanted use or temperature adjustments. Locking the Panel prevents the controller from being used, but all automatic functions are still active. Locking the Settings allows Jets and other features to be used, but the Set Temperature and other programmed settings cannot be adjusted. Settings Lock allows access to a reduced selection of menu items. These include Filter Cycles, Invert,

Information and Fault Log. They can be seen, but not changed or edited.

The Lock option can be accessed from the “Settings” menu.

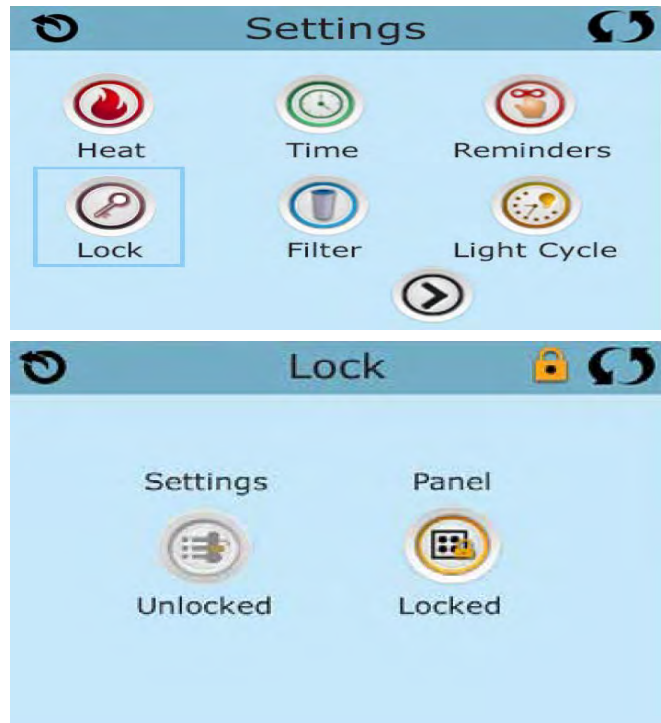

LOCKING AND UNLOCKING SETTINGS/PANEL

The settings or control panel can be locked or unlocked by following same steps.

1. To lock either Settings or Panel, first select Settings (if it says “Unlocked”) or Panel (if it says “Unlocked”) then press the word “Lock” for at least 5 seconds.
2. To unlock either Settings or Panel first select Settings (if it says “Locked”) or Panel (if it says “Locked”) then press the word “Lock” for at least 5 seconds.

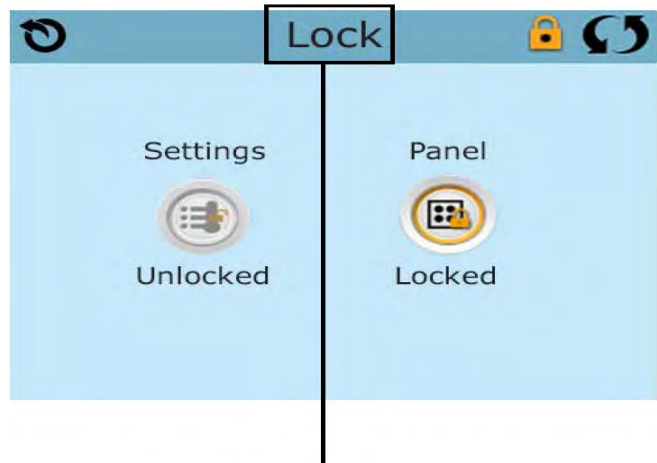

Press here for 5 seconds to lock or unlock

SWIM SPA WELLNESS (8 BUTTON) PERFORMANCE PLUS WITH VARIABLE SPEED CONTROL PANEL



	Up Arrow		Light Button
	Menu Button		Jets
	Return Arrow		Swim Function
	Down Arrow		Workout Function

INTRODUCTION

Main Screen- The main screen displays current time, water temperature, and status of the system accessories.

Priming Mode- When power is ON, the system will enter priming mode with 'Priming Mode' displayed on the panel. In this mode, all devices such as JETS, BLOWERS or LIGHT are operable. JETS can be turned on and off to prime the pump. The system will exit Priming Mode and go to the MAIN display when the RETURN button is pushed, or after 4 minutes of inactivity.

SPA OPERATION

Turn system accessories ON and OFF by pushing the button on the right side of panel (LIGHT, JET, THERAPY...). These accessories have timeout defaults from the manufacturer and will turn OFF automatically after the time has expired. Default Timeout time for LIGHT is 60 minutes; THERAPY is 15 minutes; JET at low speed is 60 minutes; and JET at high speed is 15 minutes. The user can change these default times in "DEVICE TIMEOUT" setting menu.

MENU NAVIGATION

- MENU: use to enter setting menu and sub-menu screens. For screens with several settable fields (example: DATE-TIME screen), use MENU button to navigate between different fields within the screen.
- UP and DOWN: use to navigate between different options or changing values of a field.
- RETURN: use to confirm the setting and goes back to previous screen.

SETTING TEMPERATURE

To change water Set Temperature, use UP and DOWN buttons to set the desired temperature. The screen will display "SET TEMP" with the current set temperature. After 5 seconds without change to the set temperature, the screen will go back to the MAIN screen with the current water temperature displayed. Changing the Set Temperature will turn on a pump so that the controller will be able to get an accurate water temperature and determine if the water needs to be heated.

Heater- When the heater pump turns on the HEATER START-UP icon will appear if heat is needed. The Heater will turn on and the HEATER icon will appear after 5 minutes.

Panel Timeout- If a user is in the Settings Menu and no button is pushed within 15 seconds, the screen will timeout. The current screen setting will be lost and the panel will revert back to the MAIN screen. In MAIN screen, if no button is pushed within 60 minutes, all LED and LCD lights will turn off and the panel will go to sleep. Any button pushed will wake the panel, LED and LCD lights will turn back on and the panel will Poll for water temperature.

Enter Setting Screens

Press MENU button to display a list of Setting screens.

Use UP and DOWN to navigate between various Setting screens.

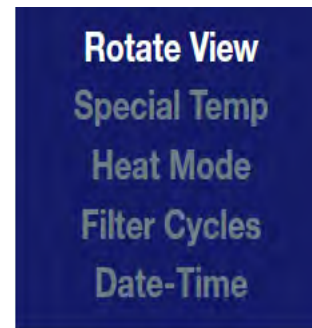

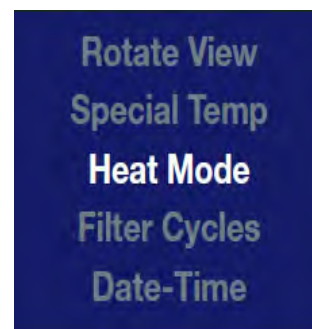

Press MENU again to enter a particular Setting screen or press RETURN to go back to MAIN screen.



SELECTION ICONS

 FILTER CYCLE 1

 FILTER CYCLE 2

 FILTER CYCLE 3

 FILTER CYCLE 4

 LIGHT ON

 HEATER ON

 HEATER START-UP

 ENERGY SAVING HEAT MODE

 VACATION HEAT MODE

 CLEANER CYCLE

 POLLING CYCLE

 TEMPERATURE LOCK

 PANEL LOCK

 OZONE ON

 JET ON LOW SPEED

 JET ON HIGH SPEED

 BLOWER ON

 SPECIAL TEMP SELECT

 OPTION

SWIM SPA & SWIM WORKOUT

1. Press the SWIM button to turn the pump ON – the SWIM icon on the LCD screen turns ON.
2. Then press UP or DOWN button to select your desired SPEED #.
3. Press the SWIM button again to turn OFF the pump the blue SWIM icon on the LCD screen turns OFF.
6. Press the **SWIM WORKOUT** button again to turn OFF the pump – the red **SWIM** icon on the LCD screen turns OFF.

SWIM WORKOUT PROGRAMMING

1. To program the SWIM WORKOUT; press the MENU button; then UP button and select SWIM **WORKOUT** by pressing the **MENU** button to get to the **WARM UP** setting.
2. Press the **UP** or **DOWN** button to select the **SPEED #** for **WARM UP**; then press the **MENU** button to select **DURATION** in minutes; then press the **MENU** button twice to get to **WORKOUT**.
3. Press the **UP** or **DOWN** button to select the **SPEED #** for **WORKOUT**; then press the **MENU** button to select **DURATION** in minutes; then press the **MENU** button twice to get to **COOL DOWN**.
4. Press the **UP** or **DOWN** button to select the **SPEED #** for **COOL DOWN**; then press the **MENU** button to select **DURATION** in minutes; then press the **RETURN** button twice to get out of **SWIM WORKOUT**.
5. Press the **SWIM WORKOUT** button to turn **ON** the pump – the red **SWIM** icon on the **LCD** screen turns **ON**. The **WORKOUT** feature will activate to cycle each of the **SPEED** setting and specific **DURATION** setting for **WORKOUT**. If you need to increase or decrease the pump speed manually; then press the UP or DOWN button to your desired SPEED # in each cycle.

SETTINGS EXPLAINED

ROTATE VIEW - Rotate the view 180 degrees. The UP and DOWN buttons also swap when rotated. With ROTATE VIEW highlighted, press MENU to enter ROTATE VIEW setting. Use UP/DOWN to select desired setting and RETURN to confirm the setting and exit.

SPECIAL TEMP - To temporarily heat spa to 105°F or 106°F once, and return to previous temperature setting. With SPECIAL TEMP highlighted, press MENU to enter SPECIAL TEMP setting. Use UP/DOWN to select the desired setting and RETURN to confirm the setting and exit.

HEAT MODE - Select STANDARD heating mode (polls every Energy Interval) for most users or ENERGY SAVING mode (polls every other Energy Interval) or VACATION mode (set temp set to 60°F). With HEAT MODE highlighted, press MENU to enter setting. Use UP/ DOWN to select the desired setting and RETURN to confirm the setting and exit.

FILTER CYCLES - set up filter cycle START TIME, DURATION, and DAY for filtering the spa. For FILTER CYCLE 1 and 2, if DURATION is set to ZERO the system will do a purge cycle at the start time setting. With FILTER CYCLE highlighted, press MENU to enter. Select a FILTER CYCLE and press MENU again to enter the TIME/DURATION setting screen. In this screen, press MENU to move between HOURS, MINUTES and DAYS; use UP/DOWN to change the values and

RETURN to exit and confirm the setting. FILTER CYCLES 3 & 4 by default are OFF. To set them, enter START TIME, DURATION and enable ALL DAYS or a specific day.

DATE-TIME - set up Date and Time for the spa. With DATE-TIME highlighted, press MENU to enter the DATE-TIME setting. In this screen, pressing MENU will move and highlight various fields that can change the setting; UP/DOWN to change the values and RETURN to confirm the setting and exit.

DEGREE F/C - displays spa temperature in Celsius or Fahrenheit. This option is only available for 60 Hz countries. Unit automatically displays Celsius for 50 Hz. With DEGREE F/C highlighted, press MENU to enter the DEGREE F/C setting. Use UP/ DOWN to select the desired setting and RETURN to confirm the setting and exit.

TIME DISPLAY - displays spa time in AM/PM or 24 hour time. With TIME DISPLAY highlighted, press MENU to enter TIME DISPLAY setting. Use UP/DOWN to select the desired setting and RETURN to confirm the setting and exit.

GENERAL INFORMATION - Displays general information for the spa. With GENERAL INFORMATION highlighted, press MENU to enter the GENERAL INFORMATION menu. Use UP/DOWN to view different pages and information, press RETURN to exit the page.

LANGUAGES - To select various languages for the spa display. With LANGUAGES highlighted, press MENU to enter and select a specific language. Use UP/DOWN to select the desired setting and RETURN to confirm the setting and exit.

DEVICES TIMEOUT - allows changes to timeout setting for various devices. LIGHT can be set to a maximum of 4 hours; PUMP in high speed and BLOWER can be set to a maximum of 1 hour; and PUMP in low speed can be set to a maximum of 2 hours. With DEVICES TIMEOUT highlighted, press MENU to enter and select various devices setting. Use UP/DOWN to select the desired time setting and RETURN to confirm the setting and exit.

PANEL LOCK - provides a choice to select PANEL for locking all panel buttons except MENU button; use TEMP to lock UP/DOWN button for changing set temperature; and MENU to lock MENU button (push and hold MENU button more than 15 seconds to unlock the Menu). With PANEL LOCK highlighted, press MENU to enter PANEL setting. Use UP/DOWN to select the desired setting and RETURN to confirm the setting and exit.

NO HEAT TIME - set the time frame for not allowing the heater to turn on. With NO HEAT TIME highlighted, press MENU to enter the NO HEAT TIME setting. In this screen, pressing MENU will move and highlight various fields that can change the setting; use UP/DOWN to change the values and RETURN to confirm the setting and exit.

SERVICE MODE - *only available for Authorized Dealers and Spa Manufacturer.*

DEMO MODE - To demonstrate all device capabilities of the spa. With DEMO MODE highlighted, press MENU to enter DEMO MODE setting. Use UP/DOWN to select the desired setting and RETURN to confirm the setting and exit. **SERENITY MODE** - Set to turn off all outputs and provide quiet while in the spa. With SERENITY MODE highlighted, press MENU to enter and select a specific time. Use UP/DOWN to select the desired time setting. Press MENU again to navigate to EXIT/START. Select the desired option and RETURN to confirm the setting and exit.

ENERGY INTERVAL - Only available for Non-Circ systems. With ENERGY INTERVAL highlighted, press MENU to enter the ENERGY INTERVAL setting. Use UP/DOWN to select the desired minutes (15-240) and RETURN to confirm the setting and exit.

SILENT TIME (FUNCTIONS PAUSE) - Only available for Non-Circ systems. Set the time frame for no polling during night or other desired periods. With SILENT TIME highlighted, press MENU to enter the SILENT TIME setting. In this screen, pressing MENU will move and highlight various fields that can change the setting; use UP/DOWN to change the values and RETURN to confirm the setting and exit.

CLEANER CYCLE - Only available for Non-Circ systems. To turn on filtration after using the spa for short cleaning period. With CLEANER CYCLE highlighted, press MENU to enter and select a specific duration. Use UP/DOWN to select the desired time setting. Press Menu again to navigate to Exit/Start. Select the desired option and RETURN to confirm the setting and exit.

UNLOCKING CONTROL PANEL

1. Power down the spa.
2. Power up the spa and hold Menu button down as soon the Coast logo comes on the control panel.
3. Keep holding the Menu button until the menu appears on the control panel.
4. Use up and down buttons to select panel lock.
5. In panel lock menu, select and highlight "off" or "unlock".
6. Keep the option highlighted until it disappears from the screen.
7. Test to confirm if the panel is unlock.

NOTE: the above instructions work for all Waterway control panels.

Error Codes Explained



Error caused when SENSOR 1 and SENSOR 3 have been plugged in incorrectly. Swap the SENSOR 1 and SENSOR 3 plug in controller to correct this problem.



Error caused by no water flow through heater or no water in heater. Check to be sure there is enough water flow through heater.

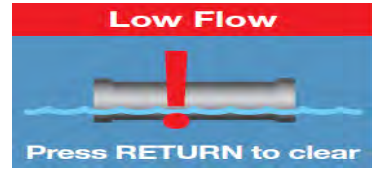

Wait for water temperature to cool down.



Wait for water temperature to cool down. Check to be sure there is enough water flow through heater.



Wait for water temperature to cool down. Check to be sure there is enough water flow through heater.



Error caused when SENSOR 1, 2, or 3 detects low temperature. All JETS and BLOWERS will turn on automatically to protect plumbing from freezing. JETS and BLOWERS will shut down when all 3 SENSORS reach a desired temperature.



Check SENSOR 1 connection



Check SENSOR 1 connection or replace SENSOR 1.



Check SENSOR 2 connection.



Check SENSOR 2 connection or replace SENSOR 2.



Check SENSOR 3 connection.



Check SENSOR 3 connection or replace SENSOR 3.

SWIM SPA WELLNESS (9 BUTTON) PERFORMANCE PLUS WITH VARIABLE SPEED CONTROL PANEL



INTRODUCTION

Main Screen - The main screen displays current time, water temperature, and status of the system accessories.

Priming Mode - When power is ON, the system will enter priming mode with 'Priming Mode' displayed on the panel. In this mode, all devices such as JETS, BLOWERS or LIGHT are operable. JETS can be turned on and off to prime the pump. The system will exit Priming Mode and go to the MAIN display when the RETURN button is pushed, or after 4 minutes of inactivity.

SPA OPERATION - Turn system accessories ON and OFF by pushing the button on the right side of panel (LIGHT, JET, THERAPY ...) These accessories have timeout defaults from the manufacturer and will turn OFF automatically after the time has expired. Default Timeout time for LIGHT is 60 minutes; THERAPY is 15 minutes; JET at low speed is 60 minutes; and JET at high speed is 15 minutes. The user can change these default times in "DEVICE TIMEOUT" setting menu.

MENU NAVIGATION

- **MENU:** use to enter setting menu and sub-menu screens. For screens with several settable fields (example: DATE-TIME screen), use MENU button to navigate between different fields within the screen.
- **UP and DOWN:** use to navigate between different options or changing values of a field.
- **RETURN:** use to confirm the setting and goes back to previous screen.

SETTING TEMPERATURE - To change water Set Temperature, use UP and DOWN buttons to set the desired temperature. The screen will display "SET TEMP" with the current set temperature. After 5 seconds without change to the set temperature, the screen will go back to the MAIN screen with the current water temperature displayed. Changing the Set Temperature will turn on a pump so that the controller will be able to get an accurate water temperature and determine if the water needs to be heated.

Heater - When the heater pump turns on the HEATER START-UP icon will appear if heat is needed. The Heater will turn on and the HEATER icon will appear after 5 minutes.

Panel Timeout - If a user is in the Settings Menu and no button is pushed within 15 seconds, the screen will timeout. The current screen setting will be lost and the panel will revert back to the MAIN screen. In MAIN screen, if no button is pushed within 60 minutes, all LED and LCD lights will turn off and the panel will go to sleep. Any button pushed will wake the panel, LED and LCD lights will turn back on and the panel will Poll for water temperature.

Enter Setting Screens

Press MENU button to display a list of Setting screens.

Use UP and DOWN to navigate between various Setting screens.

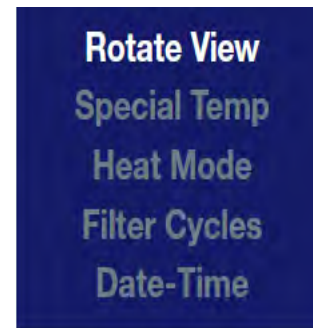

Press MENU again to enter a particular Setting screen or press RETURN to go back to MAIN screen.

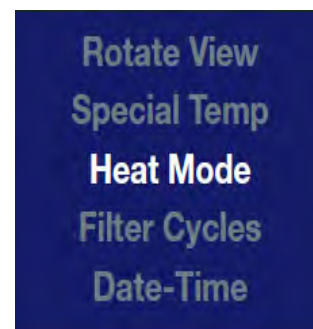

SELECTION ICONS



SWIM SPA & SWIM WORKOUT

1. Press the SWIM button to turn the pump ON – the SWIM icon on the LCD screen turns ON.
2. Then press UP or DOWN button to select your desired SPEED #.
3. Press the SWIM button again to turn OFF the pump the blue SWIM icon on the LCD screen turns OFF.

SWIM WORKOUT PROGRAMMING

1. To program the SWIM WORKOUT; press the MENU button; then UP button and select SWIM **WORKOUT** by pressing the **MENU** button to get to the **WARM UP** setting.
2. Press the **UP** or **DOWN** button to select the **SPEED #** for **WARM UP**; then press the **MENU** button to select **DURATION** in minutes; then press the **MENU** button twice to get to **WORKOUT**.
3. Press the **UP** or **DOWN** button to select the **SPEED #** for **WORKOUT**; then press the **MENU** button to select **DURATION** in minutes; then press the **MENU** button twice to get to **COOL DOWN**.
4. Press the **UP** or **DOWN** button to select the **SPEED #** for **COOL DOWN**; then press the **MENU** button to select **DURATION** in minutes; then press the **RETURN** button twice to get out of **SWIM WORKOUT**.
5. Press the **SWIM WORKOUT** button to turn **ON** the pump – the red **SWIM** icon on the **LCD** screen turns **ON**. The **WORKOUT** feature will activate to cycle each of the **SPEED** setting and specific **DURATION** setting for **WORKOUT**. If you need to increase or decrease the pump speed manually; then press the UP or DOWN button to your desired SPEED # in each cycle.

6. Press the **SWIM WORKOUT** button again to turn OFF the pump – the red **SWIM** icon on the LCD screen turns OFF.

SETTINGS EXPLAINED

ROTATE VIEW - Rotate the view 180 degrees. The UP and DOWN buttons also swap when rotated. With ROTATE VIEW highlighted, press MENU to enter ROTATE VIEW setting. Use UP/DOWN to select desired setting and RETURN to confirm the setting and exit.

SPECIAL TEMP - To temporarily heat spa to 105°F or 106°F once, and return to previous temperature setting. With SPECIAL TEMP highlighted, press MENU to enter SPECIAL TEMP setting. Use UP/DOWN to select the desired setting and RETURN to confirm the setting and exit.

HEAT MODE - select STANDARD heating mode (polls every Energy Interval) for most users or ENERGY SAVING mode (polls every other Energy Interval) or VACATION mode (set temp set to 60°F). With HEAT MODE highlighted, press MENU to enter setting. Use UP/ DOWN to select the desired setting and RETURN to confirm the setting and exit.

FILTER CYCLES - set up filter cycle START TIME, DURATION, and DAY for filtering the spa. For FILTER CYCLE 1 and 2, if DURATION is set to ZERO the system will do a purge cycle at the start time setting. With FILTER CYCLE highlighted, press MENU to enter. Select a FILTER CYCLE and press MENU again to enter the TIME/DURATION setting screen. In this screen, press MENU to move between HOURS, MINUTES and DAYS; use UP/DOWN to change the values and RETURN to exit and confirm the setting.

FILTER CYCLES 3 & 4 by default are OFF. To set them, enter START TIME, DURATION and enable ALL DAYS or a specific day.

DATE-TIME - set up Date and Time for the spa. With DATE-TIME highlighted, press MENU to enter the DATE-TIME setting. In this screen, pressing MENU will move and highlight various fields that can change the setting; UP/DOWN to change the values and RETURN to confirm the setting and exit.

DEGREE F/C - displays spa temperature in Celsius or Fahrenheit. This option is only available for 60 Hz countries. Unit automatically displays Celsius for 50 Hz. With DEGREE F/C highlighted, press MENU to enter the DEGREE F/C setting. Use UP/DOWN to select the desired setting and RETURN to confirm the setting and exit.

TIME DISPLAY - displays spa time in AM/PM or 24 hour time. With TIME DISPLAY highlighted, press MENU to enter TIME DISPLAY setting. Use UP/DOWN to select the desired setting and RETURN to confirm the setting and exit.

GENERAL INFORMATION - Displays general information for the spa. With GENERAL INFORMATION highlighted, press MENU to enter the GENERAL INFORMATION menu. Use UP/DOWN to view different pages and information, press RETURN to exit the page.

LANGUAGES - To select various languages for the spa display. With LANGUAGES highlighted, press MENU to enter and select a specific language. Use UP/DOWN to select the desired setting and RETURN to confirm the setting and exit.

DEVICES TIMEOUT - allows changes to timeout setting for various devices. LIGHT can be set to a maximum of 4 hours; PUMP in high speed and BLOWER can be set to a maximum of 1 hour; and PUMP in low speed can be set to a maximum of 2 hours. With DEVICES TIMEOUT highlighted, press MENU to enter and select various devices setting. Use UP/DOWN to select the desired time setting and RETURN to confirm the setting and exit.

PANEL LOCK - provides a choice to select PANEL for locking all panel buttons except MENU button; use TEMP to lock UP/DOWN button for changing set temperature; and MENU to lock MENU button (push and hold MENU button more than 15 seconds to unlock the Menu). With PANEL LOCK highlighted, press MENU to enter PANEL setting. Use UP/DOWN to select the desired setting and RETURN to confirm the setting and exit.

NO HEAT TIME - set the time frame for not allowing the heater to turn on. With NO HEAT TIME highlighted, press MENU to enter the NO HEAT TIME setting. In this screen, pressing MENU will move and highlight various fields that can change the setting;

use UP/DOWN to change the values and RETURN to confirm the setting and exit.

SERVICE MODE - only available for Authorized Dealers and Spa Manufacturer.

DEMO MODE - To demonstrate all device capabilities of the spa. With DEMO MODE highlighted, press MENU to enter DEMO MODE setting. Use UP/DOWN to select the desired setting and RETURN to confirm the setting and exit.

SERENITY MODE - Set to turn off all outputs and provide quiet while in the spa. With SERENITY MODE highlighted, press MENU to enter and select a specific time. Use UP/DOWN to select the desired time setting. Press MENU again to navigate to EXIT/START. Select the desired option and RETURN to confirm the setting and exit.

ENERGY INTERVAL - Only available for Non-Circ systems. With ENERGY INTERVAL highlighted, press MENU to enter the ENERGY INTERVAL setting. Use UP/DOWN to select the desired minutes (15-240) and RETURN to confirm the setting and exit.

SILENT TIME (FUNCTIONS PAUSE) - Only available for Non-Circ systems. Set the time frame for no polling during night or other desired periods. With SILENT TIME highlighted, press MENU to enter the SILENT TIME setting. In this screen, pressing MENU will move and highlight various fields that can change the setting; use UP/DOWN to change the values and RETURN to confirm the setting and exit.

CLEANER CYCLE - Only available for Non-Circ systems. To turn on filtration after using the spa for short cleaning period. With CLEANER CYCLE highlighted, press MENU to enter and select a specific duration. Use UP/DOWN to select the desired time setting. Press Menu again to navigate to Exit/Start. Select the desired option and RETURN to confirm the setting and exit.

Error Codes Explained

Plumbing Error



Press RETURN to clear

Error caused when SENSOR 1 and SENSOR 3 have been plugged in incorrectly. Swap the SENSOR 1 and SENSOR 3 plug in controller to correct this problem.

Insufficient Flow



Press RETURN to clear

Error caused by no water flow through heater or no water in heater. Check to be sure there is enough water flow through heater.

Low Flow



Press RETURN to clear

Wait for water temperature to cool down.

Water Overheat



Press RETURN to clear

Wait for water temperature to cool down. Check to be sure there is enough water flow through heater.

Heater Overheat



Press RETURN to clear

Wait for water temperature to cool down. Check to be sure there is enough water flow through heater.

Potential Freeze



Press RETURN to clear

Error caused when SENSOR 1, 2, or 3 detects low temperature. All JETS and BLOWERS will turn on automatically to protect plumbing from freezing. JETS and BLOWERS will shut down when all 3 SENSORS reach a desired temperature.

Sensor 1 open



Press RETURN to clear

Check SENSOR 1 connection

Sensor 1 short



Press RETURN to clear

Check SENSOR 1 connection or replace SENSOR 1.

Sensor 2 open



Press RETURN to clear

Check SENSOR 2 connection.

Sensor 2 short



Press RETURN to clear

Check SENSOR 2 connection or replace SENSOR 2.

Sensor 3 open



Press RETURN to clear

Check SENSOR 3 connection.

Sensor 3 short



Press RETURN to clear

Check SENSOR 3 connection or replace SENSOR 3.

SWIM SPA JET OPERATIONS 1302 BENCH PERFORMANCE SERIES

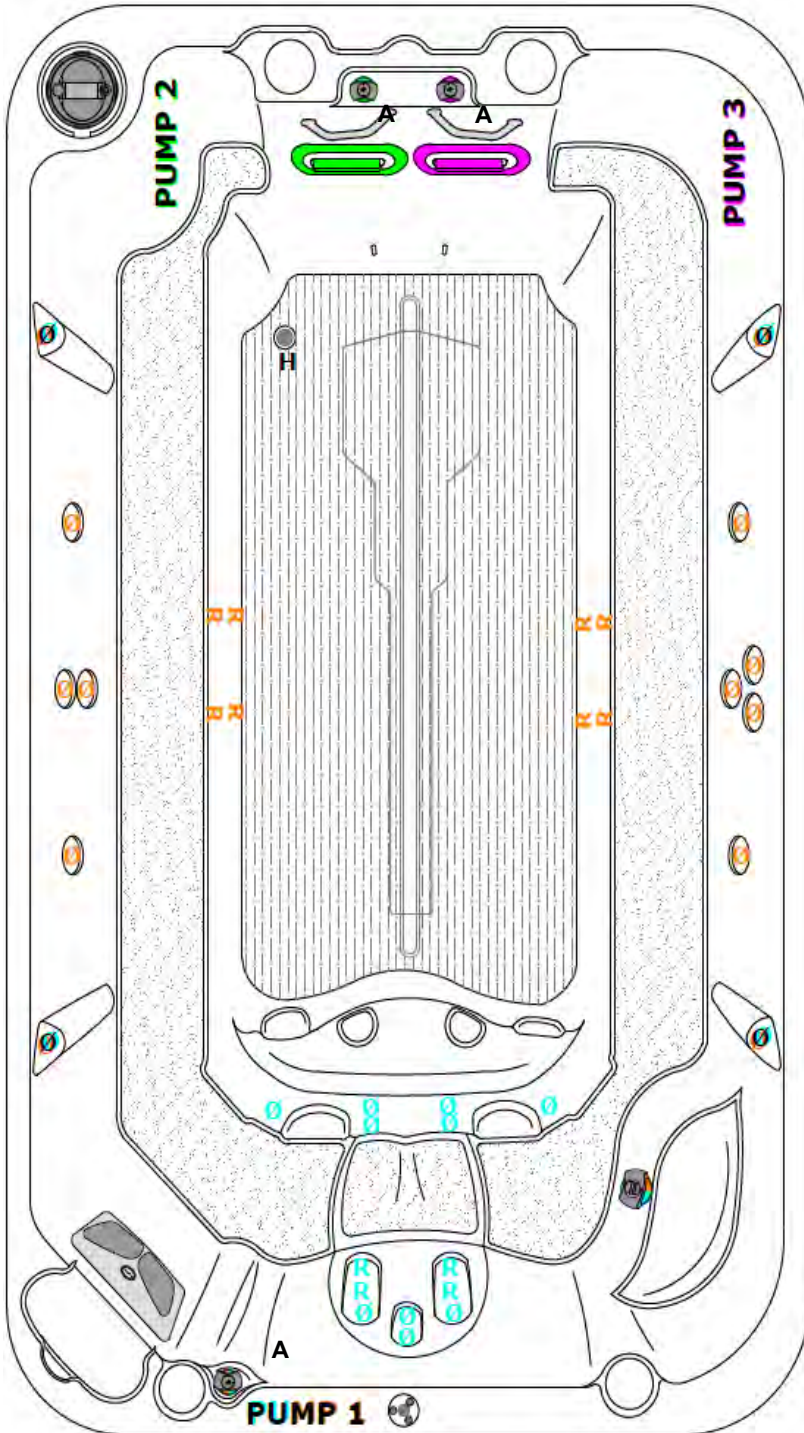

	PUMP 1
	PUMP 2
	PUMP 3

JET Note:

- ∅ = Cluster Jet
- R = Poly Jet
- 2K = Storm Jet
- 2KV = Volcano Jet
- = River Jet

Water Diverter Control

- = Blue (Right)
- = Orange (Left)

Air Control General Note:

ON () **OFF**
(GREEN, MAGENTA)
(With Check Tee)
*Rotate All The Way

(BLUE) **ON** () **ON** (ORANGE)
(ORANGE) **OFF** () **OFF** (BLUE)

WATER DIVERTER OPERATION GUIDE

- Turning water diverter "RIGHT" will operate the jets colored in **BLUE**.
- Centre position will keep all the jets flowing on low strength.
- Turning water diverter "LEFT" will operate the jets colored in **ORANGE**.

DISCLAIMER: At the time of print, this manual is accurate in its information. Coast Spas reserves all the rights to change/modify any spa designs and/or features without notification. To check on updates or for other information, please visit www.coastspas.com.

SWIM SPA JET OPERATIONS 1302 LOUNGE PERFORMANCE SERIES

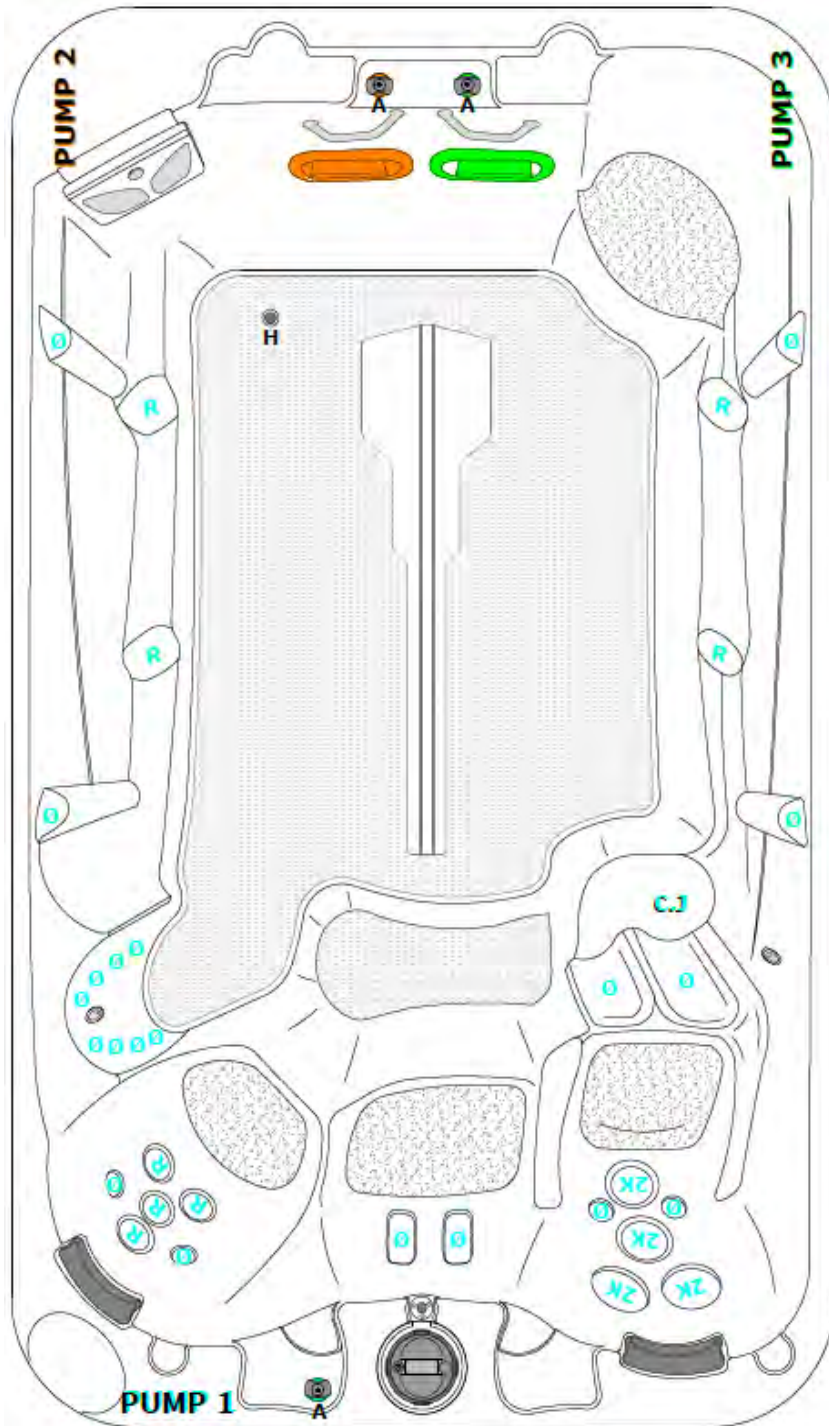

	PUMP 1
	PUMP 2
	PUMP 3

JET Note:

∅	= Cluster Jet
R	= Poly Jet
2K	= Storm Jet
2KV	= Volcano Jet
	= River Jet

Air Control General Note:

ON OFF
(BLUE, ORANGE, GREEN,)

DISCLAIMER: At the time of print, this manual is accurate in its information. Coast Spas reserves all the rights to change/modify any spa designs and/or features without notification. To check on updates or for other information, please visit www.coastspas.com



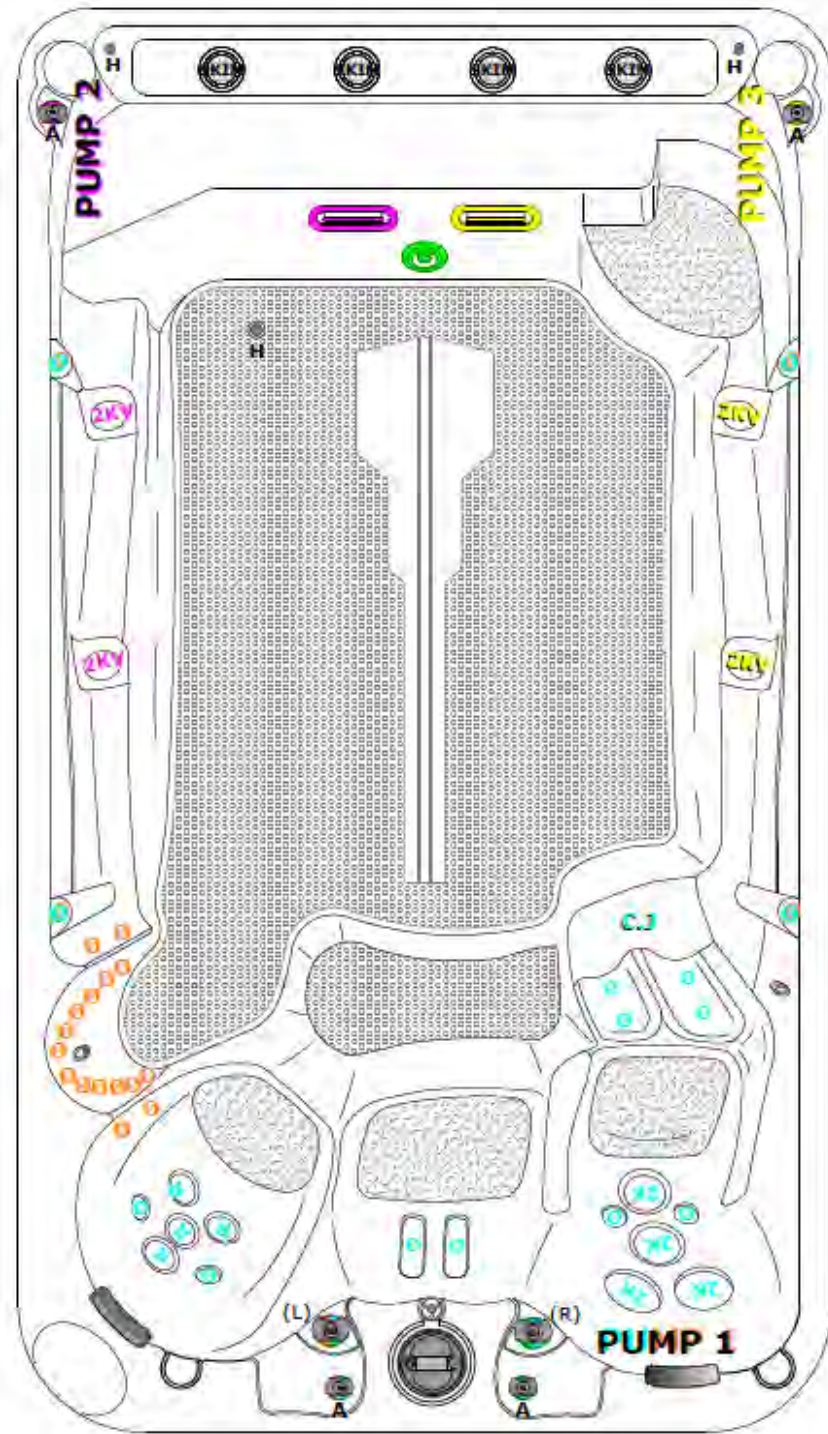

SWIM SPA JET OPERATIONS
1400 VE WELLNESS SPA® SERIES



	PUMP 1
	PUMP 2
	PUMP 3

JET Note:	
Ø	= Cluster Jet
R	= Poly Jet
2K	= Storm Jet
2KV	= Volcano Jet
	= River Jet



Water Diverter Control

-  = Green (Right)
-  = Blue (Left)
-  = Orange (Right)
-  = Blue & Green (Left)

Air Control General Note:

ON  **OFF**
(GREEN, MAGENTA, YELLOW)

*(With Check Tee)
Rotate All The Way

(BLUE) ON  **ON (ORANGE)**
(ORANGE) OFF  **OFF (BLUE)**

WATER DIVERTER OPERATION GUIDE
There are 2 water diverters in 1400 swim spa.

DIVERTER "R"

-  Turning water diverter "RIGHT" will operate the jets colored in **GREEN**.
-  Centre position will keep all the jets flowing on low strength.
-  Turning water diverter "LEFT" will operate the jets colored in **BLUE**.



DIVERTER "L"

-  Turning water diverter "RIGHT" will operate the jets colored in **ORANGE**.
-  Centre position will keep all the jets flowing on low strength.
-  Turning water diverter "RIGHT" will operate the jets colored in **BLUE** and **GREEN**.

DISCLAIMER: At the time of print, this manual is accurate in its information. Coast Spas reserves all the rights to change/modify any spa designs and/or features without notification. To check on updates or for other information, please visit www.coastspas.com.

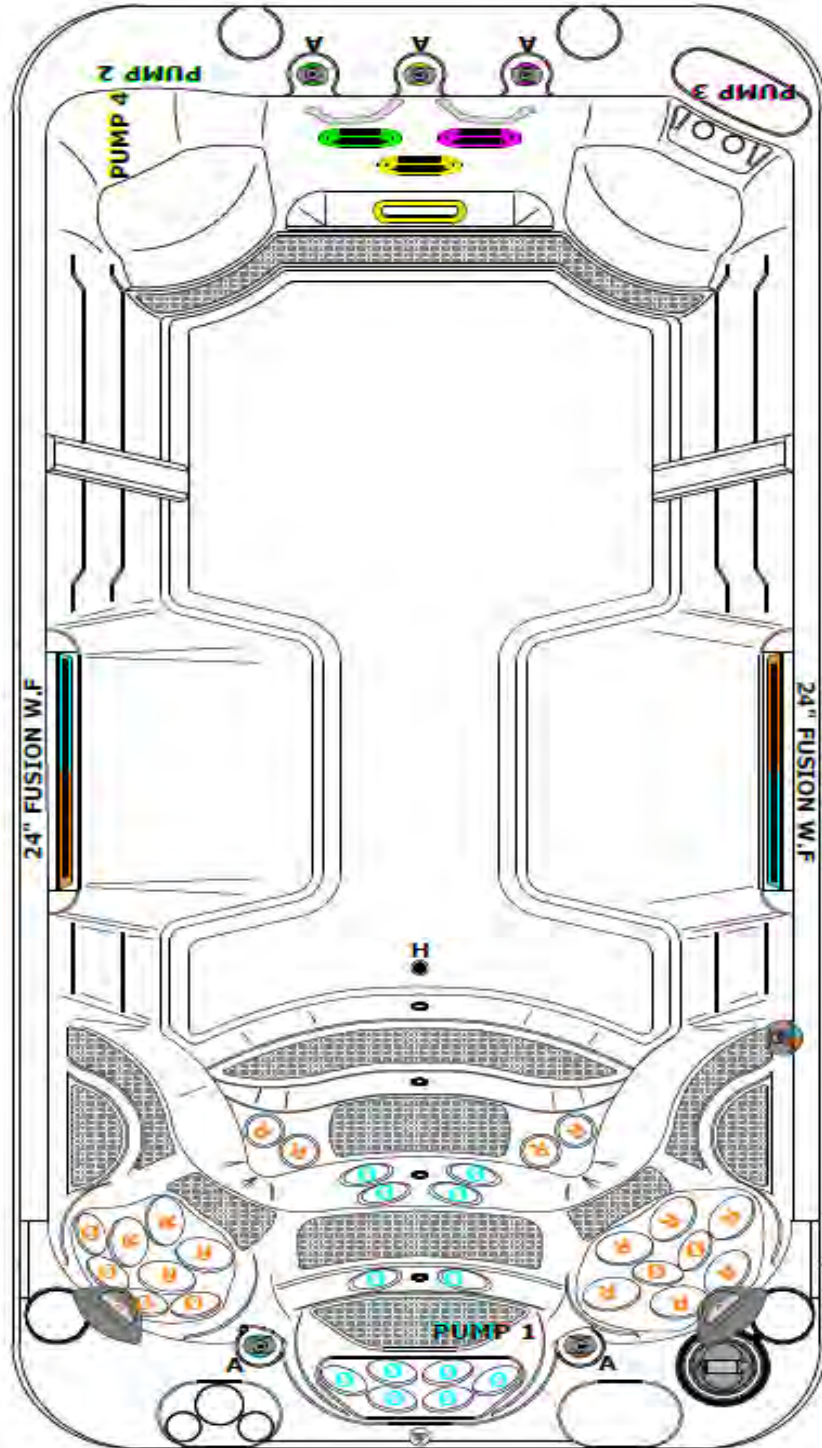
SWIM SPA JET OPERATIONS
1600 WELLNESS SPA® SERIES





	PUMP 1
	PUMP 2
	PUMP 3
	PUMP 4
	PUMP 4

JET Note:

\emptyset	= Cluster Jet
R	= Poly Jet
2K	= Storm Jet
2KV	= Volcano Jet
	= River Jet



Water Diverter Control

	= Blue (Right)
	= Orange (Left)

Air Control General Note:

ON  **OFF**
(BLUE, ORANGE, GREEN, MAGENTA, YELLOW)

WATER DIVERTER OPERATION GUIDE

	Turning water diverter "RIGHT" will operate the jets colored in BLUE .
	Centre position will keep all the jets flowing on low strength.
	Turning water diverter "LEFT" will operate the jets colored in ORANGE .

DISCLAIMER: At the time of print, this manual is accurate in its information. Coast Spas reserves all the rights to change/modify any spa designs and/or features without notification. To check on updates or for other information, please visit www.coastspas.com.

SWIM SPA JET OPERATIONS

1700 VE WELLNESS SPA® SERIES

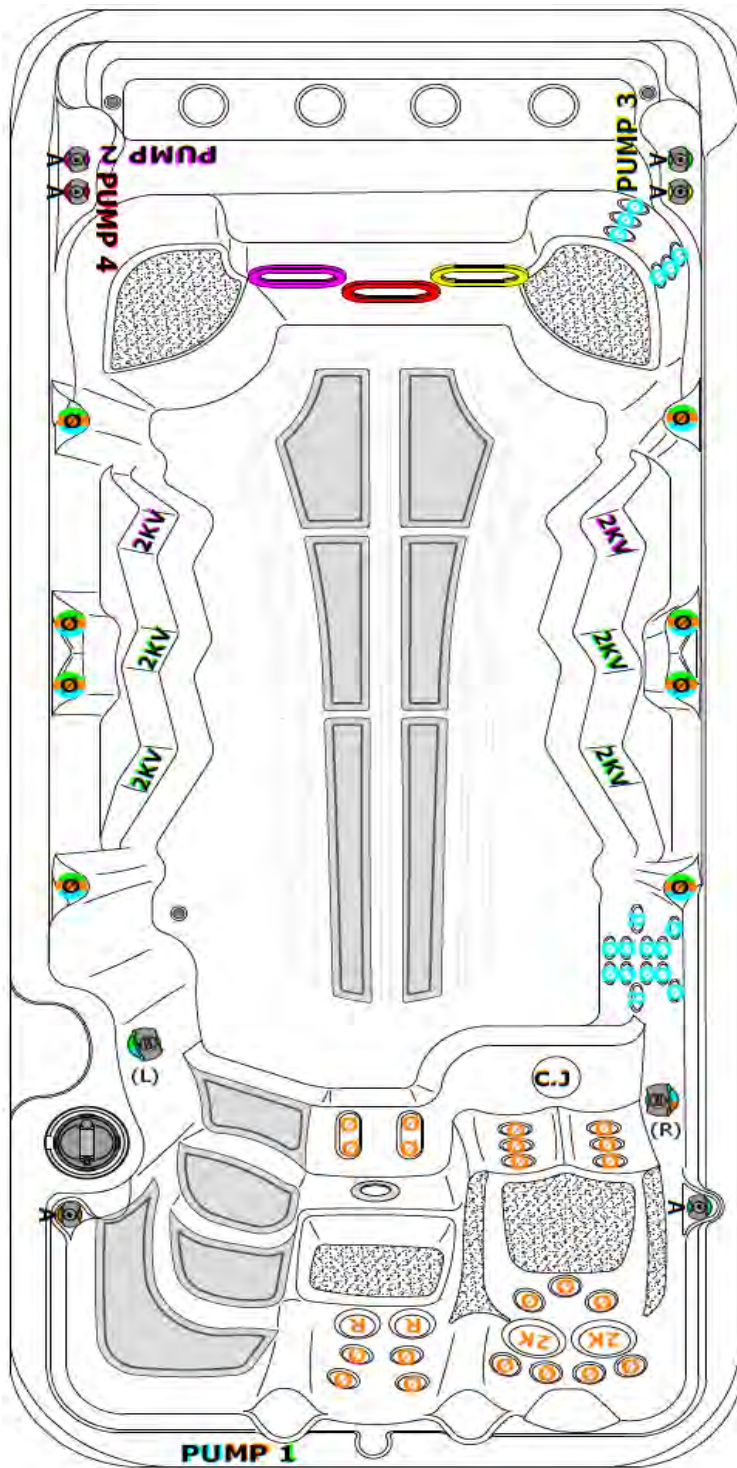





	PUMP 1
	PUMP 2
	PUMP 3
	PUMP 4

JET Note:	
Ø	= Cluster Jet
R	= Poly Jet
2K	= Storm Jet
2KV	= Volcano Jet
	= River Jet

Air Control General Note:



ON  **OFF**
 (BLUE, ORANGE, GREEN, MAGENTA, YELLOW, RED)

Water Diverter Control	
	= Orange (Right)
 (R)	= Blue (Left)
	= Green (Right)
 (L)	= Blue & Orange (Left)



WATER DIVERTER OPERATION GUIDE

There are 2 water diverters in 1700 swim spa.

DIVERTER "R"

-  Turning water diverter "RIGHT" will operate the jets colored in **ORANGE**.
-  Centre position will keep all the jets flowing on low strength.
-  Turning water diverter "LEFT" will operate the jets colored in **BLUE**.

DIVERTER "L"

-  Turning water diverter "RIGHT" will operate the jets colored in **GREEN**.
-  Centre position will keep all the jets flowing on low strength.
-  Turning water diverter "RIGHT" will operate the jets colored in **BLUE** and **ORANGE**.

DISCLAIMER: At the time of print, this manual is accurate in its information. Coast Spas reserves all the rights to change/modify any spa designs and/or features without notification. To check on updates or for other information, please visit www.coastspas.com

SWIM SPA JET OPERATIONS
2100 VE WELLNESS SPA® SERIES

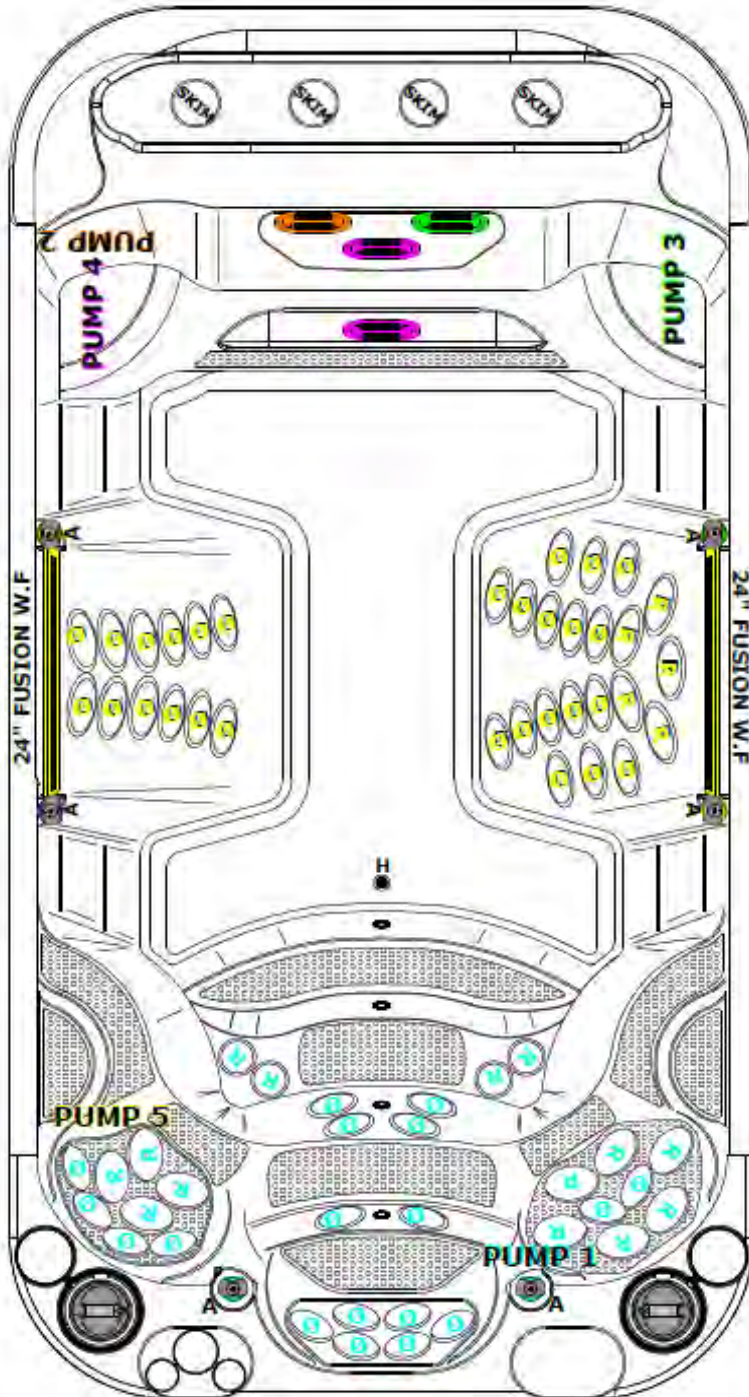

	PUMP 1
	PUMP 2
	PUMP 3
	PUMP 4
	PUMP 5

JET Note:

Ø	= Cluster Jet
R	= Poly Jet
2K	= Storm Jet
2KV	= Volcano Jet
	= River Jet

Air Control General Note:

ON () **OFF**
 (BLUE, ORANGE, GREEN,
 MAGENTA, YELLOW)

DISCLAIMER: At the time of print, this manual is accurate in its information. Coast Spas reserves all the rights to change/modify any spa designs and/or features without notification. To check on updates or for other information, please visit www.coastspas.com

SWIM SPA SPECIFICATIONS

Series	Model	Water Capacity (L)	Water Capacity US (Gal)	Dry Weight (lbs)	Dry Weight (kg)	Wet Weight (lbs)	Wet Weight (kg)	Dimensions (cm)	Dimensions (inches)
Bench	1302	5320	1405	2200	998	13929	6315	384 x 229 x 135	151 x 90 x 53
Lounge	1302	5001	1321	2100	952	13124	5953	384 x 229 x 135	151 x 90 x 53
1400 VE	1400, 1401	5190	1371	2223	1008	13664	6198	408 x 229 x 135	161 x 90 x 53
1600	1600	7950	2100	2990	1356	20516	9306	488 x 229 x 161	192 x 90 x 63.5
1700 VE	1700	7550	1994	2348	1065	18993	8615	525 x 225 x 135	207 x 88.5 x 53
2100 VE	2100	10487	2770	4000	1815	27121	12302	630 x 229 x 161	248 x 90 x 63.5

DISCLAIMER: At the time of print, this manual is accurate in its information. Coast Spas reserves all the rights to change/modify any spa designs and/or features without notification. To check on updates or for other information, please visit www.coastspas.com

BALBOA WI-FI MODULE

With the Balboa Wi-Fi Module installed in your spa follow the steps below to setup/configure the device.

Step 1: Download the app from the Google Play store or the iTunes store. The app will be titled “Coast Spas—Spa Remote” (Google) or Coast Spas—Remote Spa Control (iTunes).

Step 2: Make sure your Wi-Fi on your device is enabled. Check your device’s instructions on how to access Wi-Fi Settings.

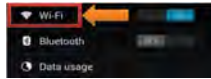

Step 3: While standing at the spa select the Wi-Fi Module from the list of available devices from your device’s Wi-Fi menu. The Wi-Fi device will appear as BWGSpa_XXXXX in the list.



Step 4: Once connected to the Wi-Fi Module directly open the Coast Spas app. The Coast Spas app will allow you to control and interact with the spa while you are still with in range.

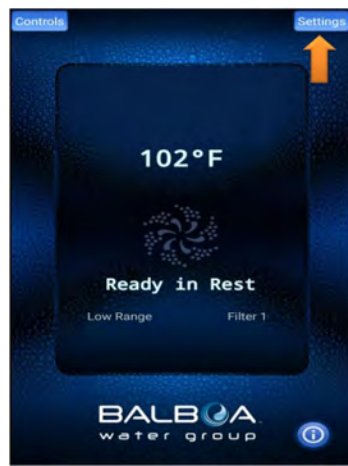
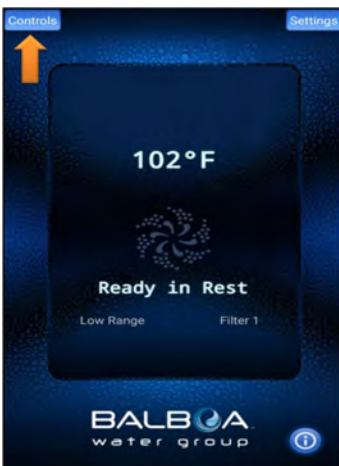

Selecting “Controls” will open a list of installed components like pump(s), blower, lights, etc.

Note: This screen will vary depending on installed components.

Selecting “Settings” will open the settings menu. While connected to the spa will be able to set the temperature, change the degrees between °F or °C, alter the heat mode (Ready/Rest), select the temperature range (low or high), set the time of day, input filter cycles (time start and duration) and have access to the advanced menu.

For more information on the various settings please refer to the selection in the owner’s manual for your control panel.

CONNECTING TO THE HOME NETWORK

Note: You can only connect the Wi-Fi app to the house network when connected directly to the Wi-Fi Module. See “Getting Started” to connect directly to the Wi-Fi Module.

Once connected to the Wi-Fi Module navigate to:

Settings ► Advanced ► Wi-Fi Settings

Step 5: Select your routers security setting. This will vary and if the wrong setting is selected the app will not be able to access the spa.

Step 6: Set your home network. Each router will have its own unique SSID (Service Set Identifier).

Step 7: Enter your key. The key will be the passkey used to sign in on your network.



Note: If you do not know or need assistance locating any of the information above please contact your locale service provider.

CONTROLMYSPA™ (LUXURY MODELS ONLY)

CMS™ SYSTEM CONSISTS OF:



WEBSITE

ControlMySpa™ website with Login and access to spas

CMS™ GATEWAY ULTRA Modules



Home Module



Spa Module

www.balboawater.com/GatewayUltra

SMARTPHONE | TABLET



iOS (Apple) ControlMySpa™ mobile app and/or Android ControlMySpa™ Mobile app

The ControlMySpa™ system consists of:

- ControlMySpa™ GATEWAY ULTRA installed on a spa/Hot Tub
- iOS (Apple) ControlMySpa™ mobile app or Android ControlMySpa™ mobile app
- ControlMySpa™ website with log-in and access to spas

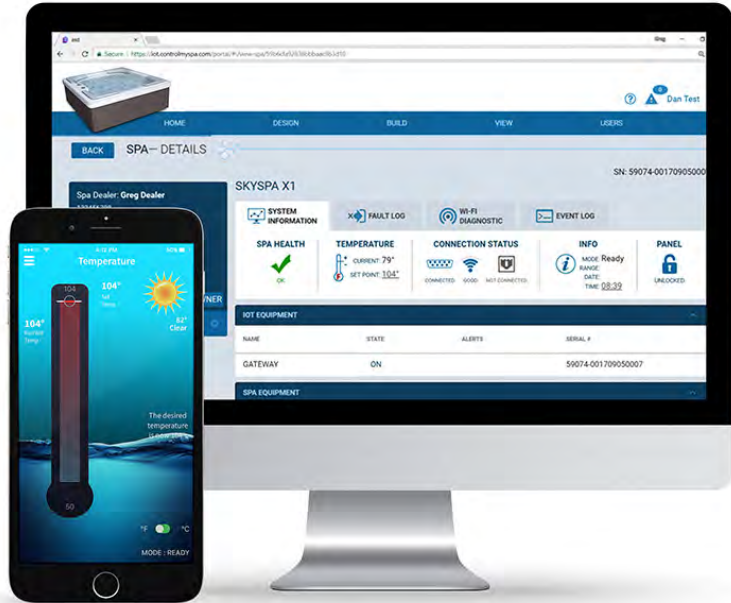

The ControlMySpa™ Logins:

- The iOS or Android ControlMySpa™ apps can only be accessed with an owner log-in
- The ControlMySpa™ website can be accessed with an owner log-in.

ControlMySpa™ App for the smart device

FOR IPHONE® OR IPAD® (IOS/APPLE)

Search the Apple iOS App Store for “controlmyspa” Or

Use this link: <https://goo.gl/j31t1V>



FOR ANDROID® PHONES/TABLETS

Search Google Play App Store for “controlmyspa”

Or Use this link: <https://goo.gl/CG4Yci>



ControlMySpa™

Connect GATEWAY ULTRA hardware in your home

Step 1

Plug the supplied ethernet cable into the home router (A).

Step 2

Plug the other end of the ethernet cable into the GATEWAY ULTRA module (B).

Step 3

Plug the supplied power cord into the GATEWAY ULTRA module (C).

Step 4

Plug the other end of the supplied power cord into wall power (D).



GATEWAY ULTRA Module (side view)

LED Light Chart (E)

This chart applies to the home and spa GATEWAY ULTRA modules.

- Red - Solid: The GATEWAY ULTRA and the spa are not connected.
- Red - Blinking: Home and spa GATEWAY ULTRA modules are connected, but no connection to the spa controller.
- Blue - Blinking: Remote software update is underway. Do not unplug power.
- Green - Blinking: CMS™ GATEWAY ULTRA spa and home modules RF is connected, but no connection to internet.
- Green - Solid: Spa successfully connected to internet. No errors.

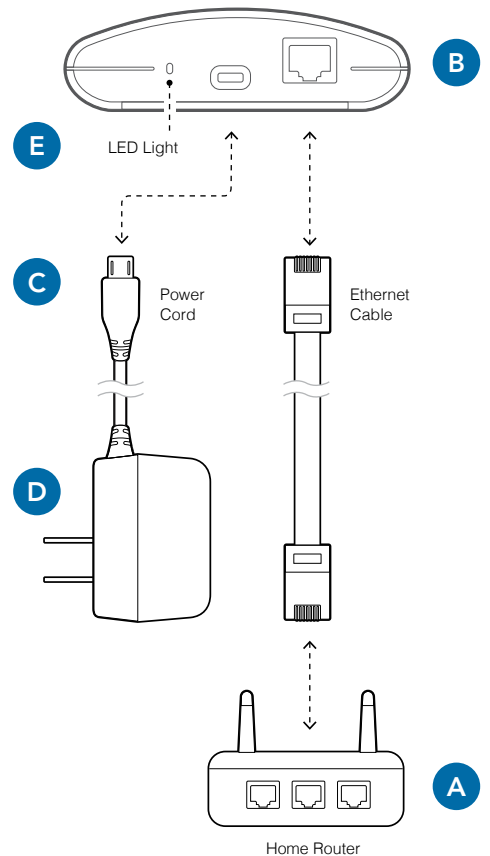

CMS™ Code Overview

WHAT IS A CMS™ CODE?

- CMS™ Code is an 8 digit letter/number combination that all Spa owners must have to use spas equipped with the ControlMySpa™ system
 - A) The CMS™ code is obtained from your Dealer.
- Spa owners will need this CMS™ code to setup and connect their spas in the ControlMySpa™ database.
- The CMS™ code connects your spa to your OEM and Dealer for service and support

EXAMPLE CMS™ Code: ABC-12345

ABC = 3 letter code unique to each spa Manufacturer or OEM 12345 = 5 number code unique to each spa Dealer or Distributor

ControlMySpa™

Setup Spa Owner User Account

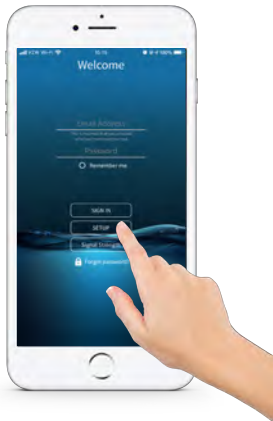

- 1. Open the app on your smart device**
Press "SETUP" on the app.



- 2. Press "Next"**
Confirm Bluetooth is ON in the iOS Settings.

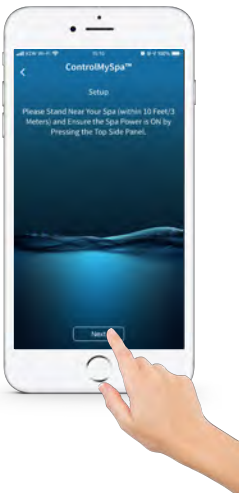

- 3. Press "Next"**
Stand near your spa (within 10 feet/3 meters) and ensure the spa power is ON by pressing the topside panel. If the spa is powered ON, press "Next".



- 4. Detect Bluetooth**



5. Press "Yes"
The serial number in the app should match the serial number on the back of the spa module.

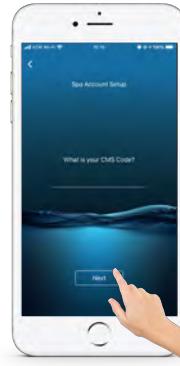

6. Press "Next"
The CMS code is provided by your Dealer. Press "Next".



7. Press "Next"
Input information and press "Next".



8. Press "Next"
Input information and press "Next".



9. Press "Next"
Input information and press "Next".



10. Press "Next"
Your UserID and password will appear. Press "Next".

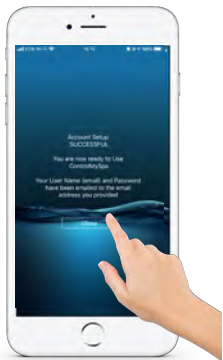

11. Press "Close"



12. Press "SIGN IN"
Input your email address, password and press "SIGN IN".

SUCCESS! YOUR ACCOUNT IS SETUP, AND YOU CAN CONTROL YOUR SPA WITH THE CMS APP.

PRV 19 STEREO SYSTEM

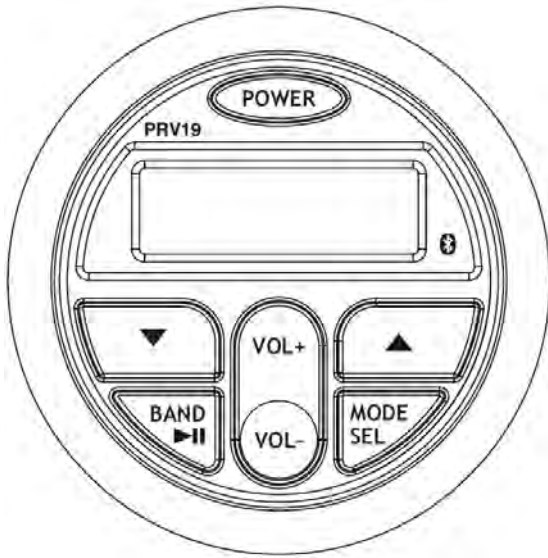

FRONT PANEL LAYOUT

Power Power On/Off

Short push for the first time to turn unit on.

With unit powered on, short push for MUTE feature.

Press and hold for more than 2 seconds to turn the unit off.

MODE Mode Function.

SEL Switches amongst Radio, USB, and Auxiliary.

SEL stands for SELECT.

BAND In Radio mode, this works Band Function.

▶|| In MP3 playing mode, it works Play/Pause function

VOL + Volume Increase

VOL - Volume Decrease

▼ Track Down/Tune Down/Reverse

▲ Track Up/Tune Up/Fast Forward

GENERAL OPERATION

- **SEL button** Press and hold this button to enter into SELECT function, then repeatedly short push in succession results in the following menu options: Bass, Treble, Balance, Fader, Loud, EQ, Beep, Initial Volume, Area. Press VOL + or VOL - to adjust the options.
- **LOUD.** Choose between Loud ON or OFF
- **EQ.** Choose between Classic, Pop, Rock, Jazz and EQ off.

- **Beep.** Choose between Beep ON, Beep 2ND, Beep OFF.
- **Initial Volume.** Refers to the loudness level upon start of the receiver.
- **Area.** Choose between USA and European.

RADIO OPERATION

- **Press ▶||** button (BAND function) to access FM and AM. There are three FM bands and two AM bands.
- **Tuning.** A short press of the ▼ or ▲ button results in a search of the station and stops at next sufficient signal strength. A long press results in manual tuning mode.

USB OPERATION

- Insert a USB stick into the USB slot. * Songs must be of the mp3 or wma format. *
- ▶|| button. Press it to pause the track. Press it again to resume play.
- ▼ and ▲ button (Track Up / Track Down)
- Short press Track Up or Track Down button to select the next or previous track. Press and hold Track Up or Track Down button to go fast forward and rewind the current

BLUETOOTH OPERATION

The Media device must Bluetooth capability in order to stream music.

- To pair your Bluetooth device, press the MODE button on the stereo until BT AUDIO appears.
- Press and hold the BAND button until PAIRING appears.
- Next, go to settings on the Bluetooth device and turn the Bluetooth option to "on".
- Select the "PRV19" from available devices. If you are prompted for a passcode enter "1234". If the stereo does not immediately pair press the BAND button. This will allow the pairing process to finalize. A noise will alert you that the devices are paired. The display will also read "CONN OK" (Connection Okay).

Note: To disconnect your device press and hold the BAND button. The display will read "DISCONN" to alert you the disconnection is complete.

Note: While playing BT Music press the ▶|| to pause or resume playback.

DM6 INSTRUCTIONS

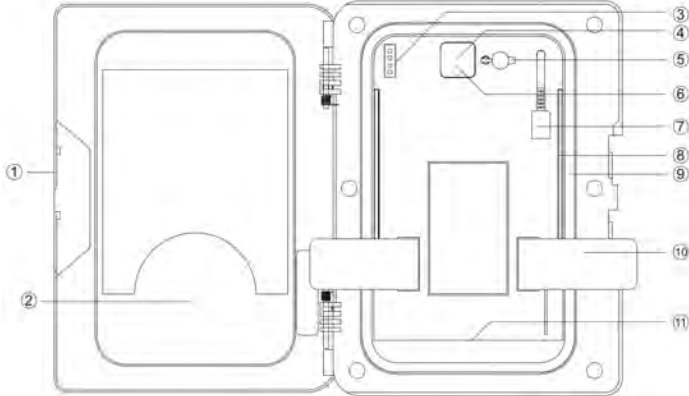

- 1. Open/Close Latch & Protective Door
- 2. Door Control Keypad
- 3. LED Mode Indicator
- 4. Power On/Standby LED
- 5. 3.5mm Aux Input for MP3 device
- 6. Power ON/OFF LED
- 7. USB Connector
- 8. Back lighting
- 9. Water/Dust Protection Gasket
- 10. Security Strap for digital media devices
- 11. Charging Compartment for Remote Control

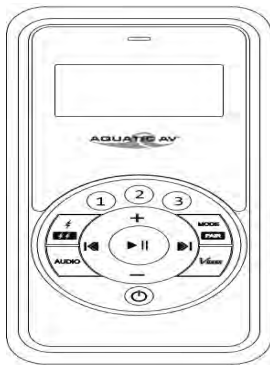

POWER ON

Press the ON/OFF button.

Red Light: Power to the docking station is ON, but the unit is in standby mode.

Blue Light: The unit is powered ON and looking for an audio source.

HANDHELD REMOTE CONTROL CHARGING

The remote has a built-in Polymer Lithium rechargeable battery and comes with a charging cable. Connect one end of the charging cable to the charging connection on remote control and connect the USB end of the charging cable to any USB charger (5V DC) for charging. Make sure the remote has been charged before used.

HANDHELD REMOTE CONTROL SYNCHRONIZING

The remote should already be paired from the factory, but if you need to synchronize the remote, follow the steps below.

- Make sure Digital Media Locker is powered ON (red LED) the place the remote within 0.5 meter of the Digital Media Locker.

Buttons	AUX IN Mode	Bluetooth Mode	USB Mode	FM Radio
Power		Press once: Toggle Operational mode to Standby mode or vice versa		
Mode/Pair		Press once: Change the source Press and hold: no function		
Volume Up		Press once: Volume up Press and hold: Fast volume up		
Volume Down		Press once: Volume down Press and hold: Fast volume down		
Fast Forward		Press once: no function Press and hold: no function	Press once: Next track Press and hold: Fast Forward	Press once: +0.05kHz Press and hold: Scan up
Fast Rewind		Press once: no function Press and hold: no function	Press once: Previous track Press and hold: Fast backward	Press once: -0.05kHz Press and hold: Scan down
Play/Pause		Press once: Toggle mute Press and hold: no function	Press once: Play/Pause Press and hold: no function	Press once: Toggle mute Press and hold: no function
1		Press once: no function Press and hold: no function	Press once: Folder up Press and hold: no function	Press once: Preset 1 Press and hold: Save to Preset 1
2		Press once: no function Press and hold: no function	Press once: no function Press and hold: Random	Press once: Preset 2 Press and hold: Save to Preset 2
3		Press once: Toggle mute Press and hold: no function	Press once: Folder down Press and hold: no function	Press once: Preset 3 Press and hold: Save to Preset 3
EXT Trigger		Press once: External Trigger 1 Press and hold: External Trigger 2		
Audio		Press once: Enter Audio Menu Press and hold: Exit Audio Menu		
V.Bass		Press once: Toggle V.Bass ON or OFF Press and hold: no function		

Buttons	AUX IN Mode	Bluetooth Mode	USB Mode	FM Radio
Mode		Press once: Change the source Press and hold: no function		
Power		Press once: Toggle Operational mode to Standby mode or vice versa		
Mode		Press once: External Trigger 1 * Press and hold: External Trigger 2 *		
Volume Up		Press once: Volume up Press and hold: Fast volume up		
Volume Down		Press once: Volume down Press and hold: Fast volume down		
Fast Forward		Press once: no function Press and hold: no function	Press once: Next track Press and hold: Fast Forward	Press once: +0.05kHz Press and hold: Scan up
Fast Rewind		Press once: no function Press and hold: no function	Press once: Previous track Press and hold: Fast backward	Press once: -0.05kHz Press and hold: Scan down
Play/Pause		Press once: Toggle mute Press and hold: no function	Press once: Play/Pause Press and hold: no function	Press once: Toggle mute Press and hold: no function
1		Press once: no function Press and hold: no function	Press once: Folder up Press and hold: no function	Press once: Preset 1 Press and hold: Save to Preset 1
2 / Random		Press once: no function Press and hold: no function	Press once: no function Press and hold: Random	Press once: Preset 2 Press and hold: Save to Preset 2
3		Press once: Toggle mute Press and hold: no function	Press once: Folder down Press and hold: no function	Press once: Preset 3 Press and hold: Save to Preset 3

- Press and hold MODE on remote control until the LCD shows "Pairing in Progress". Release the button.
- Within 2 seconds, the LCD will show "Paired". If it fails to pair, the LCD will show "Retry again". If this happens, wait 5 seconds and repeat steps above.

LISTENING VIA USB

- Attach your USB thumb drive or devices USB cable to the female USB socket of the Digital Media Locker.
- Press MODE to select USB mode.
- Press PLAY to play or pause the music.
- Press FAST REWIND / FAST FORWARD once play previous / next song file.
- Press and hold FAST REWIND / FAST FORWARD to fast forward / fast rewind the song file.

AQ-DM-6UBT—DIGITAL MEDIA LOCKER

LISTENING VIA BLUETOOTH DEVICE

- Bluetooth mode will be activated once a Bluetooth device is paired in any mode. Use MODE to change to the Bluetooth mode to listen to music.
- Play the song from device and the sound will play through the Digital Media Locker.
- Press PLAY/PAUSE to play/pause the song.
- Press FAST REWIND/FORWARD buttons to play previous/next song file.
- Press and hold FAST REWIND/FORWARD buttons to fast forward / fast rewind the song file.
- Previous/next track and volume up/down can be controlled directly from your Bluetooth device or directly from the Digital Media Locker remote control.

BLUETOOTH MULTI-LINK

A second Bluetooth device can pair to the Digital Media Locker even when it has been paired to another Bluetooth device. The second Bluetooth device will be able to play once the first device has stopped playing.

LISTENING TO FM RADIO

Press MODE on remote control to switch to FM radio mode.

Scan or Seek FM Radio Channels

- Press FAST REWIND or FAST FORWARD to seek another station.
- Press and hold either FAST REWIND or FAST FORWARD for manual tuning back or forward.

Saving Radio Channel to Memory

To save the current frequency into memory, press and hold 1, 2 or 3 for more than 2 seconds. The station will be stored into relevant button.

Listening to Saved Radio Memory

Press the 1, 2 or 3 preset button once to listen to the station stored in that button.



DEL OZONE OPERATION

- Ozone will turn on during the programmed filter cycles and pump #1 operation.
- Verify that the green light on the Ozone turns on when activated.
- Check the spa drain (at the bottom of the spa) to verify that small ozone bubbles are coming out.
- Verify that one way check valve is installed on the ozone tubing and it is working as intended.



IN.CLEAR INSTRUCTIONS

See video: <http://www.inclear.ca/inclearstartuppercedure>

For more information: <http://www.inclear.ca/inclearwater>

1. CLEAN THE SPA

It's important to completely clean the spa to remove all residues accumulated on the surface and inside or around the jet area. After draining the spa, use spa cleaning products only. Household cleaners contain additives such as phosphates which may affect the bromine production.

2. TDS (TOTAL DISSOLVED SOLIDS) CHECK

check the TDS (Total Dissolved Solids) of the water you'll use to fill the spa. Verifying the TDS range can be done by your spa selling dealer. The TDS range should be within 50 and 400 PPM. When you're certain the water is within the proper TDS range, fill your spa. If the TDS is higher than 500 PPM, ask your spa dealer for additional information to help reduce initial TDS. DO NOT use water from a "Salt Water Softener" system. Make sure there is adequate flow and that no airlocks are trapped in the unit's plumbing. If airlocks are formed, start the pump and follow the instructions in the owner's manual.

3. ADJUST WATER CHEMISTRY IN THE SPA

Proper chemical maintenance of a spa is essential for the health of bathers. Maintaining the quality of the spa water within these specified values will enhance your enjoyment of the spa and prolong the life of the In.Clear system. For best results, adjust to the following water chemistry parameters. Check these parameters periodically. **Calcium hardness (TH): between 150 and 200 PPM** **Total Alkalinity: between 100 and 120 PPM** **pH: between 7.2 and 7.8**

Water chemistry should be balanced before adding sodium bromide into the water. It's essential that the water chemistry parameters are within the proposed range to obtain optimal system performance. High Calcium Hardness may lead to faster calcification of the electrolytic plates.

4. ADD SODIUM BROMIDE (SUCH AS BROMICHARGE)

Water temperature between 32° and 38° C (90° and 100° F) helps dissolve sodium bromide and facilitates the adjustment of the maintenance level. Start the pump on high speed to allow water to circulate and slowly add sodium bromide uniformly in the spa by simply pouring it from the container. Metric Calculation: Add 0.143 kg of sodium bromide which has a guarantee of at least a 98% active ingredient, such as BromiCharge, per 100 L of water to attain 1400 ppm TDS value

(Total Dissolved Solids). Example, if your spa holds 1200 L of water, add 1.72 kg of sodium bromide (12 X 0.143 kg). Imperial Calculation: Add sodium bromide which has a guarantee of at least a 98% active ingredient, such as BromiCharge per 100 US gallons of water. Example, if your spa holds 300 US gallons of water, add 3.6 lbs of sodium bromide (3 X 1.2 lb).

Note: Your selling dealer can tell you how much water your spa holds (in liters or gallons).

MAINTENANCE MODE

Maintenance Mode keeps the bromine bank levels at a stable and acceptable range when the spa is not being used. Maintenance mode is the "everyday" mode and is automatically ON when the system is activated.

Press and hold the Program key for 2 seconds to change the maintenance mode level.

Keypad functions

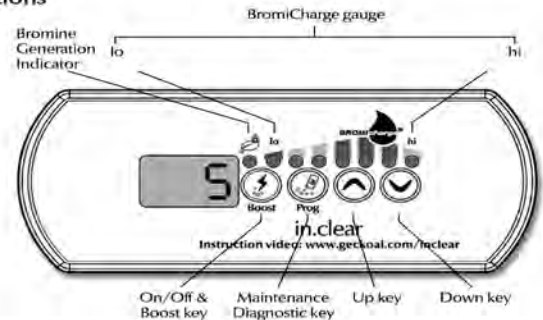

Use the Up and Down keys to adjust the maintenance level, ranges from 1 to 50.

Finding and setting the right maintenance level will keep the residual bromide level between 3 and 5 PPM (the recommended range). Once the proper maintenance level is determined, keep the same setting unless the spa conditions change (change in water temperature, spa location etc.).

BOOST MODE

The Boost Mode should be activated every time you use your spa. Boost mode increases the bromine generation rate to attack pollutants in the water and helps rebuild the necessary residual bromine in the water after each use of the spa.

If water quality is not good after use, only boost level should be adjusted, not the maintenance level.

Press the Boost key once while in maintenance mode to start a boost, or to adjust boost settings.

Use the Up and Down keys to adjust the boost level, ranges from 1 to 8.

Note: Boost levels depend on the number of bathers using the spa. We recommend you validate the Boost level after each use to determine the ideal boost level for all numbers of bathers.



WORLD'S BEST BUILT SPAS

